

Sisteme de jgheaburi metalice din sârmă



Cuprins

72

Sistem de jgheaburi metalice din sârmă - H35

72

Sistem de jgheaburi metalice din sârmă - H50

72

Sistem de jgheaburi metalice din sârmă - H100

73

Grafice încărcare jgheaburi sârmă

74

Sisteme de montaj și fixare

77

Asortimentul

Sisteme de jgheaburi metalice din sârmă

Sistem de jgheaburi din sârmă H35

Jgheaburi metalice din sârmă

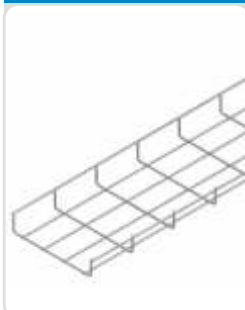

TIP	LĂȚIME A, mm	ÎNĂLȚIME H, mm	LUNGIME L, mm	GROSIME Sârmă, D mm	GREUTATEA kg/m	COD ARTICOL
SR 35x50	50	35	3000	4	0,455	ATK-05-04
SR 35x100	100	35	3000	4	0,617	ATK-10-04
SR 35x150	150	35	3000	4	0,777	ATK-15-04
SR 35x200	200	35	3000	4	0,936	ATK-20-04
SR 35x300	300	35	3000	4	1,256	ATK-30-04
SR 35x400	400	35	3000	4	1,575	ATK-40-04
SR 35x500	500	35	3000	4	1,895	ATK-50-04
SR 35x600	600	35	3000	4	2,214	ATK-60-04

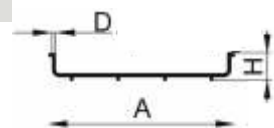
**MATERIALUL:**

- sârmă din oțel zincat galvanic

Sistem de jgheaburi din sârmă H50

Jgheaburi metalice din sârmă

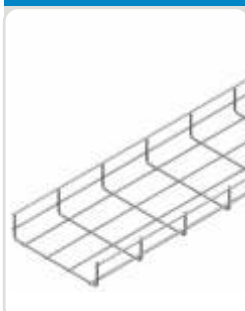

TIP	LĂȚIME A, mm	ÎNĂLȚIME H, mm	LUNGIME L, mm	GROSIME Sârmă, D mm	GREUTATEA kg/m	COD ARTICOL
SR 50x50	50	50	3000	4	0,682	ATK-05-14
SR 50x100	100	50	3000	4	0,841	ATK-10-14
SR 50x150	150	50	3000	4	1,002	ATK-15-14
SR 50x200	200	50	3000	4	1,165	ATK-20-14
SR 50x300	300	50	3000	4	1,488	ATK-30-14
SR 50x400	400	50	3000	4	1,810	ATK-40-14
SR 50x500	500	50	3000	4	2,131	ATK-50-14
SR 50x600	600	50	3000	4	2,453	ATK-60-14

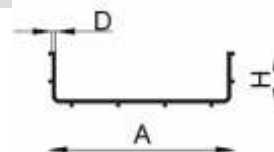
**MATERIALUL:**

- sârmă din oțel zincat galvanic

Sistem de jgheaburi din sârmă H100

Jgheaburi metalice din sârmă H100

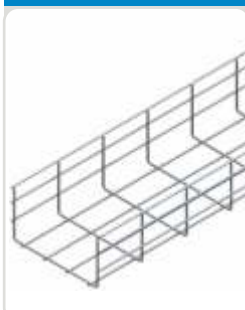

TIP	LĂȚIME A, mm	ÎNĂLȚIME H, mm	LUNGIME L, mm	GROSIME Sârmă, D mm	GREUTATEA kg/m	COD ARTICOL
SR 100x100	100	100	3000	4	1,106	ATK-10-24
SR 100x150	150	100	3000	4	1,319	ATK-15-24
SR 100x200	200	100	3000	4	1,488	ATK-20-24
SR 100x300	300	100	3000	4	1,810	ATK-30-24
SR 100x400	400	100	3000	4	2,131	ATK-40-24
SR 100x500	500	100	3000	4	2,453	ATK-50-24
SR 100x600	600	100	3000	4	2,776	ATK-60-24

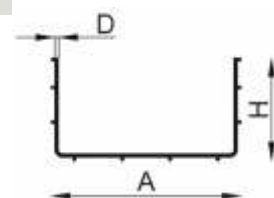
**MATERIALUL:**

- sârmă din oțel zincat galvanic

Capac Jgheab metalic din sârmă

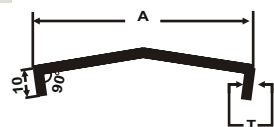

Tip	Lățime A, mm	Înălțime H, mm	Lungime L, mm	Grosime Capac, T mm	Greutatea kg/m	Cod articol
Capac 50	50	16	3000	0,7	0,451	ATK-05-K
Capac 100	100	16	3000	0,7	0,725	ATK-10-K
Capac 150	150	16	3000	0,7	1,000	ATK-15-K
Capac 200	200	18	3000	0,9	1,667	ATK-20-K
Capac 300	300	22	3000	0,9	2,430	ATK-30-K
Capac 400	400	22	3000	1,2	4,182	ATK-40-K
Capac 500	500	22	3000	1,2	5,124	ATK-50-K
Capac 600	600	22	3000	1,2	6,066	ATK-60-K

**MATERIALUL:**

- oțel zincat galvanic

Sisteme de jgheaburi metalice din sârmă

Grafice încărcare jgheaburi din sârmă

H35

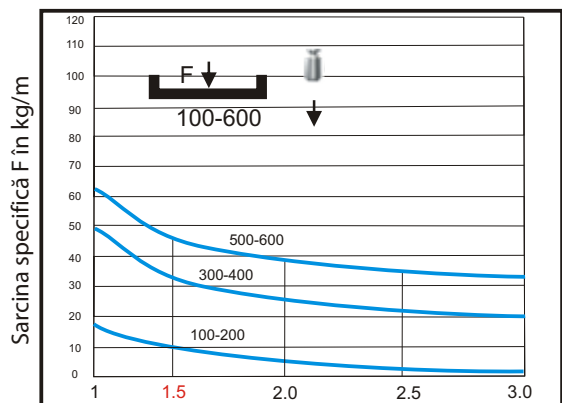

Distanța dintre prinderi (m)

Distanța dintre prinderi Standard 1.5 m
Încovoierea Standard 15 mm



H50

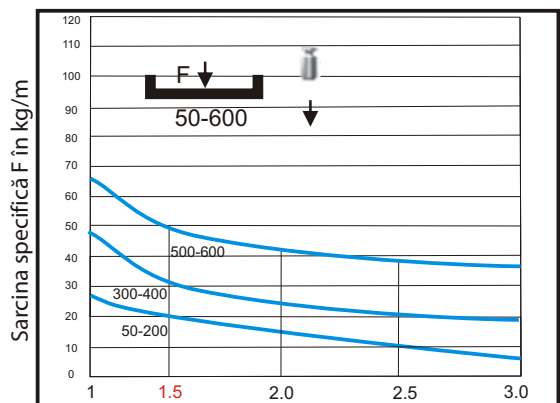

Distanța dintre prinderi (m)

Distanța dintre prinderi Standard 1.5 m
Încovoierea Standard 15 mm



H100

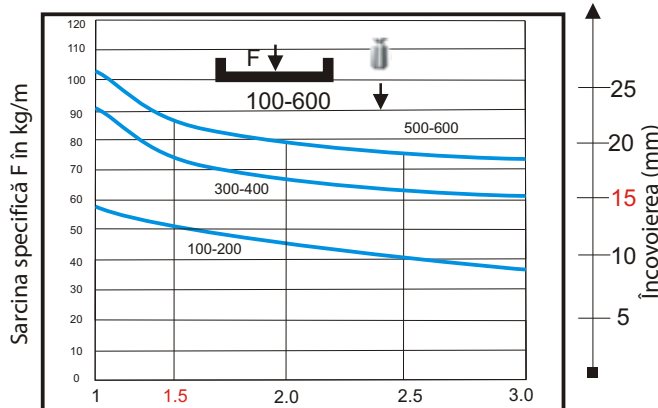

Distanța dintre prinderi (m)

Distanța dintre prinderi Standard 1.5 m
Încovoierea Standard 15 mm



Realizarea diferitelor accesorii prin tăiere

COT ORIZZONTAL

PIESĂ T ORIZZONTALĂ

REDUCȚIE

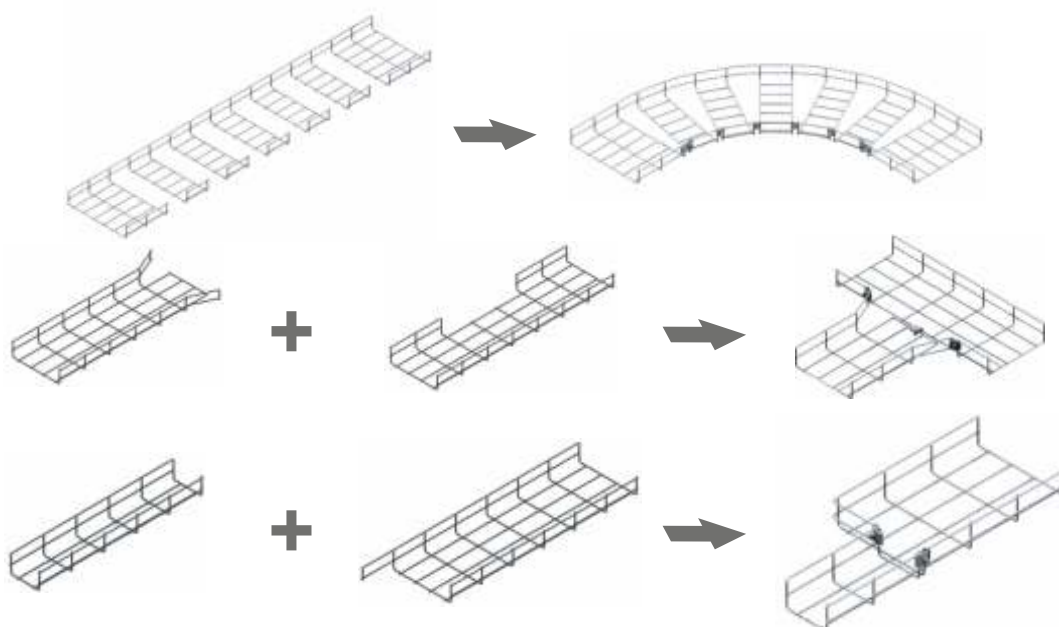

Sisteme de jgheaburi metalice din sârmă

Sisteme de fixare și montaj

Piesă de îmbinare



TIP	GROSIME T, mm	GREUTATEA kg/buc	COD ARTICOL
Piesă îmbinare	3	0,039	ATK-6-1

MATERIALUL:
• oțel zincat galvanic

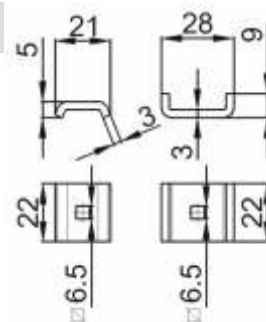

Piesă de prindere pe consolă



TIP	GROSIME T, mm	GREUTATEA kg/buc	COD ARTICOL
Piesă de prindere pe consolă	3	0,035	ATK-6-1-U

MATERIALUL:
• oțel zincat galvanic

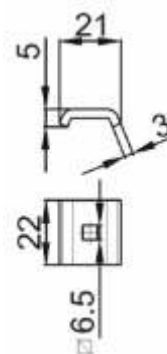
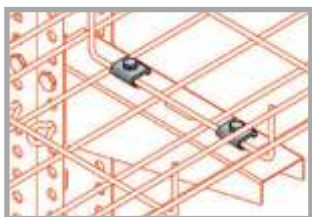

Piesă de legătură rapidă



TIP	GROSIME T, mm	GREUTATEA kg/buc	COD ARTICOL
Piesă legătură rapidă	1	0,072	ATK-8

MATERIALUL:
• oțel zincat galvanic

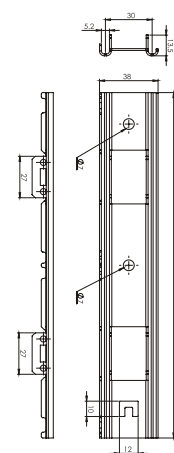

Piesă prindere pe lateral



TIP	GROSIME T, mm	GREUTATEA kg/mbuc	COD ARTICOL
Piesă prindere pe lateral	3	0,077	ATK-2-1-U

MATERIALUL:
• oțel zincat galvanic

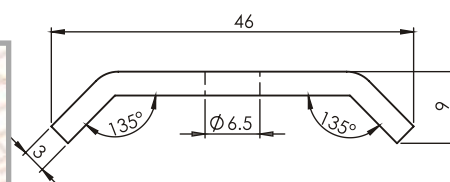

La comandă sistemul de trasee pentru cabluri poate fi galvanizat la cald.

Sisteme de jgheaburi metalice din sârmă

Sisteme de fixare și montaj

Piesă de atârnare cu tijă filetată



TIP	GROSIME T, mm	GREUTATEA kg/buc	COD ARTICOL
Piesă de atârnare 12	2	0,045	ATK-12
Piesă de atârnare 11	2	0,045	ATK-11

MATERIALUL:
• oțel zincat galvanic

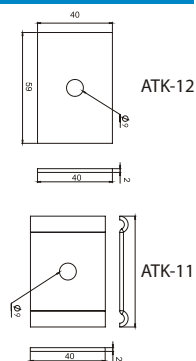
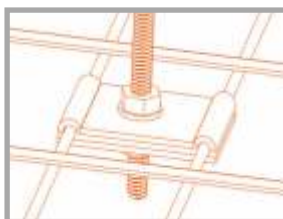

Piesă de atârnare cu tijă filetată



TIP	GROSIME T, mm	GREUTATEA kg/buc	COD ARTICOL
Piesă de atârnare	4	0,086	ATK-10

MATERIALUL:
• oțel zincat galvanic

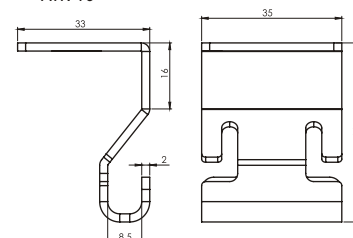
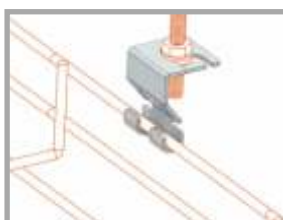

Consolă jgheab sârmă



TIP	LUNGIME L, mm	GROSIME D mm	GREUTATEA kg/buc	COD ARTICOL
Consolă 70	70	1,5	0,121	ATK6-07
Consolă 100	100	1,5	0,155	ATK6-10
Consolă 160	160	1,5	0,218	ATK6-16
Consolă 200	200	1,5	0,250	ATK6-20
Consolă 300	300	2,0	0,609	ATK6-30
Consolă 400	400	2,0	0,782	ATK6-40
Consolă 500	500	2,0	0,957	ATK6-50
Consolă 600	600	2,0	1,127	ATK6-60

MATERIALUL:
• oțel zincat galvanic

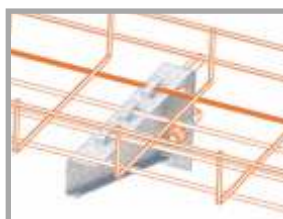

Consolă sudată jgheab sârmă



TIP	LUNGIME L, mm	GROSIME D mm	GREUTATEA kg/buc	COD ARTICOL
Consolă sudată 70	70	1,5	0,170	ATK6-07K
Consolă sudată 100	100	1,5	0,200	ATK6-10K
Consolă sudată 160	160	1,5	0,251	ATK6-16K
Consolă sudată 200	200	1,5	0,286	ATK6-20K
Consolă sudată 300	300	1,5	0,714	ATK6-30K
Consolă sudată 400	400	1,5	0,865	ATK6-40K
Consolă sudată 500	500	1,5	1,016	ATK6-50K
Consolă sudată 600	600	1,5	1,167	ATK6-60K

MATERIALUL:
• oțel zincat galvanic



Sisteme de jgheaburi metalice din sârmă

Sisteme de fixare și montaj

Bridă distanțieră 30



TIP	LUNGIME L, mm	GROSIME D mm	GREUTATEA kg/buc	COD ARTICOL
Bridă distanțieră 50	50	2	0,073	AYDT-05-3
Bridă distanțieră 100	100	2	0,089	AYDT-10-3
Bridă distanțieră 160	160	2	0,115	AYDT-16-3
Bridă distanțieră 200	200	2	0,133	AYDT-20-3
Bridă distanțieră 300	300	3	0,258	AYDT-30-3
Bridă distanțieră 400	400	3	0,325	AYDT-40-3
Bridă distanțieră 500	500	3	0,383	AYDT-50-3
Bridă distanțieră 600	600	3	0,450	AYDT-60-3

MATERIALUL:
• oțel zincat galvanic

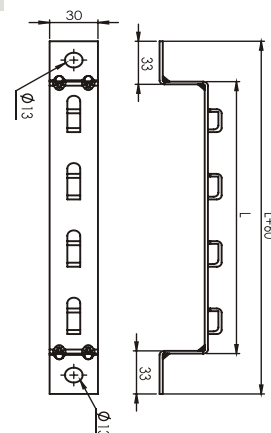
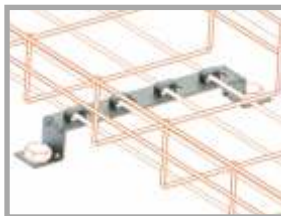

Profil suspendare



TIP	LUNGIME L, mm	GROSIME D mm	GREUTATEA kg/buc	COD ARTICOL
Profil suspendare 160	220	2	0,306	ATK5-5-16
Profil suspendare 200	260	2	0,357	ATK5-5-20
Profil suspendare 300	360	2	0,497	ATK5-5-30
Profil suspendare 400	460	2	0,636	ATK5-5-40
Profil suspendare 500	560	2	0,771	ATK5-5-50
Profil suspendare 600	660	2	0,911	ATK5-5-60

MATERIALUL:
• oțel zincat galvanic

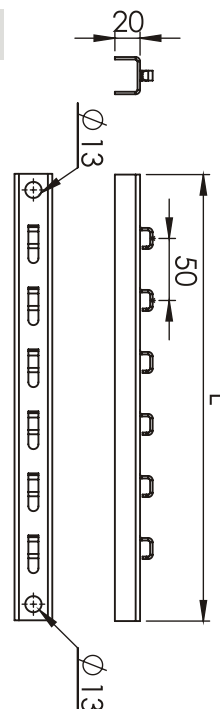

Placă pentru prinderea dozelor





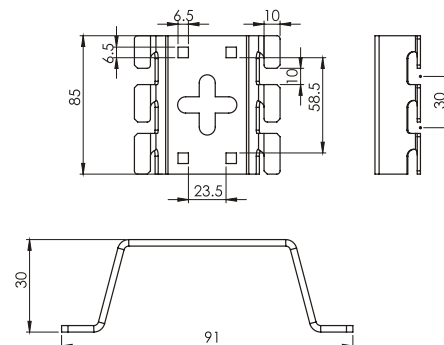

TIP	ÎNĂLȚIME H, mm	GROSIME D mm	GREUTATEA kg/buc	COD ARTICOL
Placă prindere doză	30	2	0,153	ATK-13

MATERIALUL:
• oțel zincat galvanic

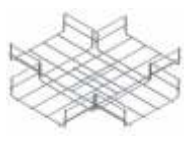

Asortimentul

H, Înălțime	A, Lățime	Cot orizontal 90°	Piesă T orizontală	Piesă cruce	Cot coborâre flexibil	Cot ridicare flexibil
						
50	100	ATK-D10-14	ATK-T10-14	ATK-C10-14	ATK-DB10-14	ATK-IB10-14
	200	ATK-D20-14	ATK-T20-14	ATK-C20-14	ATK-DB20-14	ATK-IB20-14
	300	ATK-D30-14	ATK-T30-14	ATK-C30-14	ATK-DB30-14	ATK-IB30-14
	400	ATK-D40-14	ATK-T40-14	ATK-C40-14	ATK-DB40-14	ATK-IB40-14
	500	ATK-D50-14	ATK-T50-14	ATK-C50-14	ATK-DB50-14	ATK-IB50-14
	600	ATK-D60-14	ATK-T60-14	ATK-C60-14	ATK-DB60-14	ATK-IB60-14
100	100	ATK-D10-24	ATK-T10-24	ATK-C10-24	ATK-DB10-24	ATK-IB10-24
	200	ATK-D20-24	ATK-T20-24	ATK-C20-24	ATK-DB20-24	ATK-IB20-24
	300	ATK-D30-24	ATK-T30-24	ATK-C30-24	ATK-DB30-24	ATK-IB30-24
	400	ATK-D40-24	ATK-T40-24	ATK-C40-24	ATK-DB40-24	ATK-IB40-24
	500	ATK-D50-24	ATK-T50-24	ATK-C50-24	ATK-DB50-24	ATK-IB50-24
	600	ATK-D60-24	ATK-T60-24	ATK-C60-24	ATK-DB60-24	ATK-IB60-24

