

SACC-MINFS-4CON-PG13 - Connector



1521355

<https://www.phoenixcontact.com/ro/produse/1521355>

Vă rugăm să țineți cont de faptul că datele afișate în acest document PDF au fost generate din catalogul nostru online. Datele complete sunt disponibile în documentația pentru utilizator. În cazul descărcărilor, se aplică Termenii și condițiile generale de utilizare ale companiei noastre.



Connector, Universal, 4-position, Socket straight 7/8"-16UNF, coding: A, Screw connection, knurl material: Zinc die-cast, nickel-plated, cable gland Pg13,5, external cable diameter 10 mm ... 12 mm

Avantajele dumneavoastră

- Safe use in the field, thanks to a high degree of protection
- Screw connection: proven connection technology for a large selection of different conductors

Date comerciale

Număr articol	1521355
Unitate de ambalare	1 Bucată
Cantitate minimă pentru comandă	1 Bucată
Cod produs	BF2FAA
Pagina de catalog	Pagina 25 (C-2-2017)
GTIN	4017918949587
Greutate pe bucată (inclusiv ambalajul)	55,4 g
Greutate pe bucată (fără ambalaj)	48 g
Cod tarifar vamal	85366990
Țara de origine	DE

SACC-MINFS-4CON-PG13 - Connector



1521355

<https://www.phoenixcontact.com/ro/produse/1521355>

Date tehnic

Notes

General	NOTE: Observe the permissible bending radii when laying conductors, since the degree of protection may be put in jeopardy if the bending forces are too high. Alleviate mechanical loads upstream of the connector, e.g. by using cable ties.
---------	------------------------------------------------------------------------------------------------------------------------------------------------------------------------------------------------------------------------------------------------------

Mounting

Assembly instructions	The wires can be connected both with ferrules and without ferrules
-----------------------	--------------------------------------------------------------------

Product properties

Product type	Circular connector (cable-side)
Sensor type	Universal
Number of positions	4
No. of cable outlets	1
Shielded	no
Coding	A
Cable outlet	straight
Pg screw connection	Pg13,5

Insulation characteristics

Overvoltage category	III
Degree of pollution	3

Dimensions

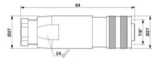
Dimensional drawing	
Width	27 mm
Height	27 mm
Length	84 mm

External dimensions

Outside diameter	10 mm ... 12 mm
------------------	-----------------

Housing

Diameter housing	27 mm
------------------	-------

Material specifications

Flammability rating according to UL 94	HB
Material of grip body	PBT
Contact material	CuZn
Contact surface material	Au

SACC-MINFS-4CON-PG13 - Connector



1521355

<https://www.phoenixcontact.com/ro/produse/1521355>

Contact carrier material	PUR/PA 6.6
Material for screw connection	Zinc die-cast, nickel-plated

Connection data

Conductor connection

Connection method	Screw connection
Connection cross section	0.34 mm ² ... 1.5 mm ² (without ferrule)
	0.34 mm ² ... 1.5 mm ² (with ferrule)
	0.34 mm ² ... 1.5 mm ² (solid)
Connection cross section AWG	22 ... 16 (without ferrule)
	22 ... 16 (with ferrule)
Stripping length of the individual wire	7 mm
Tightening torque	0.8 Nm (7/8" connectors)
	0.4 Nm (Screw terminal blocks)
	1 Nm ... 1.4 Nm (Pressure screw)

Electrical properties

Rated surge voltage	4 kV
Contact resistance	≤ 5 mΩ
Insulation resistance	≥ 100 MΩ
Nominal voltage U _N	300 V AC
	300 V DC
Nominal current I _N	9 A

Mechanical properties

Mechanical data

Insertion/withdrawal cycles	≥ 100
-----------------------------	-------

Connector

Connection 1

Head design	Socket
Head cable outlet	straight
Head thread type	7/8"-16UNF
Coding	A

Cable/line

Signal type/category	Universal
Stripping length of the individual wire	7 mm

Environmental and real-life conditions

Ambient conditions

Degree of protection	IP67
Ambient temperature (operation)	-25 °C ... 85 °C (Plug / socket)

SACC-MINFS-4CON-PG13 - Connector



1521355

<https://www.phoenixcontact.com/ro/produse/1521355>

Desene

Dimensional drawing

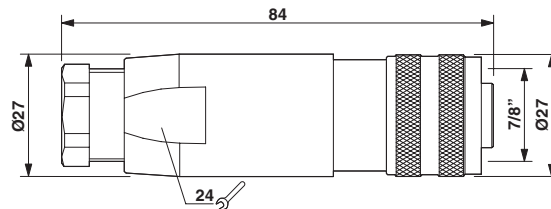

Socket 7/8"-16UNF, straight, Pg13

Schematic diagram

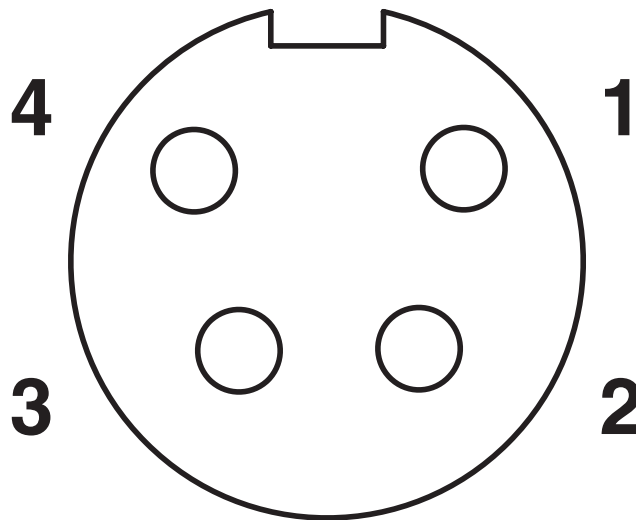

Pin assignment, socket, 7/8"-16UNF, 4-pos., view of female side

SACC-MINFS-4CON-PG13 - Connector

1521355

<https://www.phoenixcontact.com/ro/produse/1521355>

Functional drawing

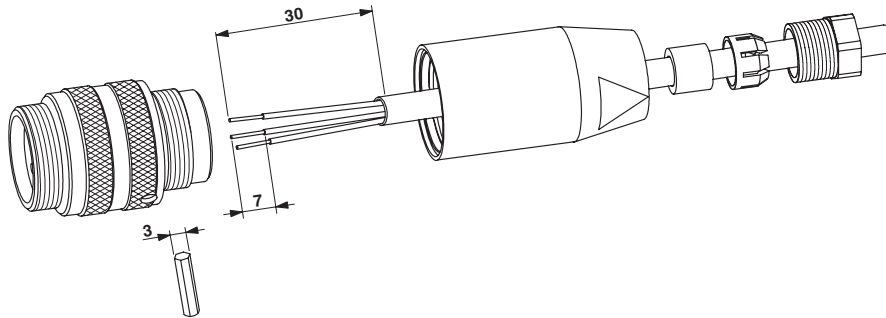

SACC-MINFS-4CON-PG13 - Connector





1521355

<https://www.phoenixcontact.com/ro/produse/1521355>

Aprobări

To download certificates, visit the product detail page: <https://www.phoenixcontact.com/ro/produse/1521355>

 cUL Recognized ID de înregistrare: FILE E 221474				
	Tensiune nominală U_N	Curent nominal I_N	Secțiune transversală AWG	Secțiune transversală mm^2
	600 V	9 A	-	-

 UL Recognized ID de înregistrare: FILE E 221474				
	Tensiune nominală U_N	Curent nominal I_N	Secțiune transversală AWG	Secțiune transversală mm^2
	600 V	9 A	-	-

 EAC ID de înregistrare: RU C-DE.BL08.B.00511				
--------------------------------------------------------------------------------------------------------------------------------------------	--	--	--	--

cULus Recognized				
-------------------------	--	--	--	--

SACC-MINFS-4CON-PG13 - Connector



1521355

<https://www.phoenixcontact.com/ro/produse/1521355>

Clasificări

ECLASS

ECLASS-11.0	27440102
ECLASS-12.0	27440116
ECLASS-13.0	27440116

ETIM

ETIM 9.0	EC002635
----------	----------

UNSPSC

UNSPSC 21.0	39121400
-------------	----------

1521355

<https://www.phoenixcontact.com/ro/produce/1521355>

Environmental product compliance

REACH SVHC	Lead 7439-92-1
China RoHS	Environmentally Friendly Use Period = 50 years
	For information on hazardous substances, refer to the manufacturer's declaration available under "Downloads"

SACC-MINFS-4CON-PG13 - Connector



1521355

<https://www.phoenixcontact.com/ro/produce/1521355>

Accesorii

PROT-MINMS-PA-CHAIN - Screw plug

1430925

<https://www.phoenixcontact.com/ro/produce/1430925>

7/8" sealing cap made of plastic with fixing band, for sensor cables, for 7/8" sockets



TSD 08 SAC - Torque screwdriver

1212597

<https://www.phoenixcontact.com/ro/produce/1212597>

Torque screw driver with preset torque of 0.8 Nm, with 4 mm hexagon for accommodating SAC bits, two-component handle with non-slip grip



SACC-MINFS-4CON-PG13 - Connector



1521355

<https://www.phoenixcontact.com/ro/produce/1521355>

TSD-M 1,2NM - Torque screwdriver

1212224

<https://www.phoenixcontact.com/ro/produce/1212224>



Torque screw driver, accuracy as per EN ISO 6789 standard, adjustable from 0.3 - 1.2 Nm

TSD-M SAC-BIT ADAPTER - Adapter insert

1212600

<https://www.phoenixcontact.com/ro/produce/1212600>



Adapter bit for TSD-M...torque tools, E6.3-1/4" drive with 4 mm hexagon to accommodate SAC bits

SACC-MINFS-4CON-PG13 - Connector

1521355

<https://www.phoenixcontact.com/ro/produse/1521355>



SAC BIT MIN-D25 - Tool

1212512

<https://www.phoenixcontact.com/ro/produse/1212512>

Nut for assembling 7/8" connectors with a knurl diameter of 25 mm, with 4 mm hexagonal drive



Phoenix Contact 2024 © - Toate drepturile rezervate

<https://www.phoenixcontact.com>

PHOENIX CONTACT România

Splaiul Unirii 165 Timpuri Noi Square TNO1, Etaj 1

Bucuresti 030133

+40 21 350 88 12 - 3

sales.ro@phoenixcontact.com