



Page 11-4

**GA SERIES
16A TO 160A (AC21A)**

- Switch disconnectors with direct operating handle and door coupling version
- Switch disconnectors door mount version
- Switch disconnectors in non-metallic enclosure
- Changeover switches in non-metallic enclosure.



Page 11-16

**GE SERIES
50A TO 1600A (AC21A)**

- Three and four-pole switch disconnectors
- Three and four-pole switch disconnectors with NFC, NH and BS type fuse holders
- Three and four-pole changeover switches; add-on motorised control unit available.



Page 11-24

**FOR PHOTOVOLTAIC APPLICATIONS
UP TO 850A 1000VDC (DC21B)**

- Direct operating and door coupling versions
- Switch disconnectors in non-metallic enclosure.



- 16A to 1600A ratings
- Versions: direct operating handle, door coupling, door mount and in plastic enclosure
- Wide range of accessories
- Types for photovoltaic applications up to 850A 1000VDC (DC21B)
- Changeover switches in polycarbonate enclosure.

GA series 16A to 160A

	SEC. - PAGE
Three-pole switch disconnectors	11 - 4
Fourth pole add on.....	11 - 4
Add-on blocks and accessories	11 - 5
Empty enclosures	11 - 11
Enclosed switch disconnectors	11 - 12
Enclosed changeover switches	11 - 14
GE series 50A to 1600A	
Three-pole switch disconnectors	11 - 16
Three-pole switch disconnectors with fuse holder	11 - 16
Four-pole switch disconnectors	11 - 17
Four-pole switch disconnectors with fuse holder	11 - 17
Three-pole changeover switches	11 - 18
Four-pole changeover switches	11 - 18
Add-on blocks and accessories	11 - 19
For photovoltaic applications	11 - 24
Dimensions	11 - 26
Wiring diagrams	11 - 30
Technical characteristics	11 - 32

GA series 16A to 160A



AC21A	DIRECT OPERATING HANDLE AND DOOR COUPLING VERSION										DOOR MOUNT VERSION							
	36mm/1.42" width					70mm/2.75" width					36mm/1.42" width				70mm/2.75" width			
	16A	25A	32A	40A	63A	63A	80A	100A	125A	160A	16A	25A	32A	40A	63A	80A	100A	125A
Three pole	●	●	●	●	●	●	●	●	●	●	●	●	●	●	●	●	●	●
4th pole - simultaneous closing		●			●	●	●	●	●	●		●			●	●	●	●
4th pole - early make		●			●		●					●				●		
Three-pole for photovoltaic applications				●														
Fuse holder		●																
Mechanical 6-8 pole coupling system			●				●											
Mechanical interlock for line switching		●					●											



AC21A ≤ 690V (IEC/EN)	ENCLOSED VERSION - IEC/EN TYPE IP65 WITH RED/ YELLOW OR BLACK HANDLE										ENCLOSED VERSION UL/CSA TYPE 4/4X WITH RED/ YELLOW OR BLACK HANDLE									
	16A	25A	32A	40A	63A	63A	80A	100A	125A	160A	16A	25A	32A	40A	63A	63A	80A	100A	125A	160A
General use 600VAC (UL/CSA)											16A	25A	32A	40A	60A	60A	100A	100A	100A	—
	Enclosure width					Enclosure width					Enclosure width					Enclosure width				
	100mm/3.94"			175mm/6.89"			220mm/8.66"		100mm/3.94"			175mm/6.89"		220mm/8.66"						
SWITCH DISCONNECTORS																				
Three pole	●	●	●	●	●	●	●	●	●	●	●	●	●	●	●	●	●	●	●	●
Four pole	●		●	●	●	●		●	●	●	●		●		●	●		●	●	●
CHANGEOVER SWITCHES																				
						Enclosure width					Enclosure width									
						175mm/6.89"					220mm/8.66"									
Three pole							●		●	●		●		●			●		●	●
Four pole							●		●	●		●		●			●		●	●

GE series 50A to 1600A

Switch disconnectors

Changeover switches



AC21A	DIRECT OPERATING AND DOOR COUPLING VERSION													
	50A	125A	160A	200A	250A	315A	400A	500A	630A	800A	1000A	1250A	1600A	
SWITCH DISCONNECTORS 50A TO 1600A														
Three and four pole			●	●	●	●	●	●	●	●	●	●	●	
Three and four pole with NFC fuse holder	●	●												
Three and four pole with NH fuse holder			●		●		●		●	●				
Three and four pole with BS fuse holder			●	●	●	●	●		●	●				
Four-pole for photovoltaic applications		●			●	●			●	●		●		
CHANGEOVER SWITCHES 160A TO 1600A														
Three and four pole			●	●	●	●	●	●	●	●	●	●	●	
Motorised control unit			●		●	●			●			●		

VERSATILITY!

- COMPACT SIZE**
 The three-pole 16A to 63A switch disconnectors, are made up of a single unit body, merely 36mm/1.42" wide, while the 63A to 160A ratings, of another body size of only 70mm/2.75" wide.
- ACCESSORY FLEXIBILITY**
 Mounting and removal of the fourth pole and add-on blocks are simple and quick operations with no need for tools.
- VERSIONS FOR PHOTOVOLTAIC APPLICATIONS**
 The GA... and GD type switch disconnectors are suitable for both small domestic installations as well as those with a large number of solar cells. Use up to 1000V in DC21B category.



- CERTIFICATIONS**
 The 16A to 63A types are listed for Canada and the USA, certified according to UL508/CSA C22.2 n° 14. The 63A to 125A types are listed for Canada and the USA, certified according to UL98A/CSA C22.2 n° 4.



- SIDE MOUNT ADD-ON FOURTH POLE**

Simultaneous closing or early-make contact operation of the fourth pole with respect to the switch disconnector poles.



- ADD-ON AUXILIARY CONTACTS**

Only one add-on block suitable for all the 9 ratings of switch disconnectors, having simultaneous closing with the switch disconnector poles. There are versions with an early-break NO contact with respect to the switch disconnector.

- MAXIMUM COMBINATIONS**

Mounting up to 4 auxiliary contacts or 1 fourth pole and 3 auxiliary contacts (2 blocks always on the right and 2 on the left side) of each switch disconnector. The earth and neutral terminals and fuse holder also can be added.



- DOOR COUPLING HANDLE WITH FRONT DIMENSIONS 48X48MM**

The GAX68 and GAX68B handles can be used in panels and boxes of limited dimensions.



- 6 AND 8 POLE VERSION**

Mechanical coupling systems are available for the 16A to 160A switch disconnectors with direct operating handle to provide 6/8 pole disconnectors or a mechanical interlock mechanism for the line changeover function (I - 0 - II). The enclosed switches are cULus certified.



- FUSE HOLDERS**



A three-pole fuse holder can be added to 16A to 32A switch disconnectors, with direct operating handle, to provide a single compact unit. Access to the fuse can be made only when the disconnector is in OFF position.

- REDUCED HANDLE THICKNESS**

GAX61 and GAX 61 B handles are only 23mm thick.

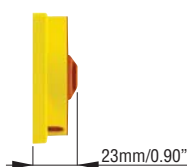

- IP65 PADLOCKABLE HANDLES**

Wide range of selector or pistol grip handles, with screw or ring fixing. All handles are equipped with built-in padlockable mechanism. The selector handle GAX63... snaps onto the door mount switch disconnectors in 16A to 40A ratings, with no need for tools.



- HANDLE ADAPTABILITY**

The extensive number of fixing holes in the front handle plate can replace switch disconnectors, normally found out in the field, without having to drill others.



- UL508A HANDLE VERSION**

In compliance with UL508A standards, which require internal panel inspection by authorised personnel with power applied, selector and pistol handles are available with defeatable feature of the door coupling when the switch disconnector is closed, i.e. in ON position.



- SWITCH STATUS INDICATION**

The switch open or closed state is clearly and unequivocally seen at a distance thanks to the simple and modern design of the handles.

- DIN RAIL FIXING**

Switch disconnector mounting on and removal from the 35mm DIN rail are done by simply pressing it downwards with no need for tools.

- ANTI-SLIDE INSERT FOR DIN RAIL**

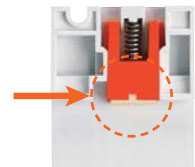

A rubber pad insert prevents the sliding of switch disconnectors on the DIN rail even when out of tolerance or mounted vertically.

- TERMINAL ADAPTABILITY**

Terminals are suitable to accept any type of cable: flexible, rigid, AWG wire. The terminals can withstand high tightening torques.

- HIGH IEC CAPABILITY IN AC23**

The rated currents I_n in AC23 at 690VAC are the highest of the category.

- MODULARITY**

The switch disconnectors can be mounted in modular panels.

Three-pole switch disconnectors



GA016 A...
GA040 A
GA063 SA



GA063 A...
GA160 A

new



GA016 C...
GA040 C



GA063 C...
GA125 C

Order code	IEC conventional free air thermal current Ith AC21A (≤690V)	IEC rated operational current Ie AC22A (≤690V) AC23A (≤415V)	Qty per pkg	Wt
	[A]	[A]	n°	[kg]

Direct operating version, complete with black handle.
For door coupling version, separately purchase the handle and shaft extension (see page 11-8 and 11-10).

GA016 A	16	16	1	0.146
GA025 A	25	25	1	0.146
GA032 A	32	32	1	0.146
GA040 A	40	40	1	0.146
GA063 SA	63	45	1	0.148
GA063 A	63	63	1	0.388
GA080 A	80	80	1	0.388
GA100 A	100	100	1	0.388
GA125 A	125	125	1	0.388
GA160 A	160	125	1	0.388

Door mount version, complete with shaft extension (purchase handle separately, see page 11-8).

GA016 C	16	16	1	0.170
GA025 C	25	25	1	0.170
GA032 C	32	32	1	0.170
GA040 C	40	40	1	0.170
GA063 C	63	63	1	0.404
GA080 C	80	80	1	0.404
GA100 C	100	100	1	0.404
GA125 C	125	125	1	0.404

Fourth pole add on



GAX42...A
GAX41...A
GAX42 063SA
GAX41 063SA

new



GAX42 040C
GAX41 040C

Order code	IEC conventional free air thermal current Ith AC21A (≤690V)	IEC rated operational current Ie AC22A (≤690V) AC23A (≤415V)	Qty per pack	Wt
	[A]	[A]	n°	[kg]

Simultaneous closing operation as switch disconnector poles. For GA...A version.

GAX42 040A ^①	40	40	1	0.045
GAX42 063A ^②	63	45	1	0.045
GAX42 063A	63	63	1	0.126
GAX42 080A	80	80	1	0.126
GAX42 100A	100	100	1	0.126
GAX42 125A	125	125	1	0.126
GAX42 160A	160	125	1	0.126

For GA...C version.

GAX42 040C ^③	40	40	1	0.045
GAX42 063C	63	63	1	0.128
GAX42 080C	80	80	1	0.128
GAX42 100C	100	100	1	0.128
GAX42 125C	125	125	1	0.128

Early make closing operation with respect to switch disconnector poles. For GA...A version.

GAX41 040A ^④	40	40	1	0.046
GAX41 063SA ^⑤	63	45	1	0.046
GAX41 125A ^⑥	125	125	1	0.116

For GA...C version.

GAX41 040C ^③	40	40	1	0.046
GAX41 125C ^③	125	125	1	0.128

- ① For GA016 A...GA040 A only.
- ② For GA063 SA only.
- ③ For GA016 C...GA040 C only.
- ④ For GA063 A...GA125 A only.
- ⑤ For GA063 C...GA125 C only.
- ⑥ For GA063 C...GA125 C only.

General characteristics

- 16A to 160A
- Available versions:
 - Direct operating
 - Door mount
 - Door coupling. Use switch disconnector with direct operating handle and separately purchase the handle and shaft extension for this version. See pages 11-8 and 10.
- Compact and modular size
- Screw or 35mm DIN rail fixing
- Padlockable in 0 position with no extra accessory.

Operational characteristics

- Rated insulation voltage Ui: 1000V
- Rated impulse withstand Uimp: 8kV
- Electrical life in AC21A:
 - 100,000 cycles GA016...GA040, GAX...40A/C
 - 15,000 cycles GA063 SA, GAX...063SA
 - 30,000 cycles GA063...GA125, GAX...063...125A/C
 - 1,500 cycles GA160A, GAX42 160A
- Mechanical life:
 - 100,000 cycles GA016...GA040 A/C, GA063 SA, GAX...40A/C, GAX...063SA
 - 30,000 cycles GA063...GA160A, GAX...063...125A/C, GAX42 160A.

Certifications and compliance

Certifications obtained:

Type	cULus according to UL508 / CSA C22.2 no. 14	cULus according to UL98A / CSA C22.2 no. 4	EAC	KEMA
GA016 A...GA040 A	●	—	●	●
GA063 SA	●	—	●	—
GA016 C...GA040 C	●	—	●	●
GA063 A...GA125 A	—	●	●	—
GA160 A-GAX42 160A	—	—	●	—
GA063 C...GA125 C	—	●	●	—
GAX41 040A-GAX42 040A	●	—	●	—
GAX41 063SA-GAX42 063SA	●	—	●	—
GAX41 040C-GAX42 040C	●	—	●	—
GAX41 125A-GAX42 125C	—	●	●	—
GAX42 063A...GAX42 125A	—	●	●	—
GAX42 063C...GAX42 125C	—	●	●	—

● Certification obtained.

Compliant with standards: IEC/EN 60947-3, IEC/EN 60947-1, UL508, UL98A, CSA C22.2.

Strokes of GA poles (main poles and add-on pole)

	Travel 0 → 1	0°	30°	60°	90°
GA016A/C...GA040A/C - GA063SA Main poles				60°	
GAX42040A/C - GAX42063SA Simultaneous closing fourth-pole add on				60°	
GAX41040A/C - GAX41063SA Early-make fourth-pole add on				55°	
GA063A/C...GA125A/C, GA160A Main poles				55°	
GAX42063A/C...GAX42125A/C, GAX42160A Simultaneous closing fourth-pole add on				55°	
GAX41125A/C Early-make fourth-pole add on				48°	
	OFF				ON

Add-on blocks



GAX11 10EA
GAX12 10EA



GAX3...A GAX3...C



GAX50...
GAX60...

Order code	Characteristics	Qty per pack	Wt
		n°	[kg]
Auxiliary contacts, simultaneous closing as poles of switch disconnector.			
GAX10 11A	1NO + 1NC for GA...A, GA063 SA and GA040 D	1	0.030
GAX10 11C	1NO + 1NC for GA...C	1	0.030
Auxiliary contacts, early-break operation with respect to poles of switch disconnector.			
GAX11 10EA	1EB (NO) for GA016 A...GA040 A, GA063 SA and GA040 D	1	0.035
GAX12 10EA	1EB (NO) for GA063 A...GA160 A	1	0.035
Neutral terminal.			
GAX31 A	For GA016 A...GA040 A, GA063 SA and GA040 D	1	0.040
GAX32 A	For GA063 A...GA160 A	1	0.110
GAX31 C	For GA016 C...GA040 C	1	0.040
GAX32 C	For GA063 C...GA125 C	1	0.110
Earth/Ground terminal.			
GAX33 A	For GA016 A...GA040 A, GA063 SA and GA...D	1	0.040
GAX34 A	For GA063 A...GA160 A	1	0.110
GAX33 C	For GA016 C...GA040 C	1	0.040
GAX34 C	For GA063 C...GA125 C	1	0.110
Mechanical interlock for line changeover (I-O-II).			
GAX50 00	For GA016 A...GA040 A, GA063 SA, GA040 D and GAX67 B; □ 5mm/0.2" ❶	1	0.050
GAX50 01	For GA063 A...GA160 A and GAX67 B; □ 5mm/0.2" ❶	1	0.075
Mechanical coupling system for 6-8 pole switch disconnectors.			
GAX60 00	For GA016 A...GA040 A, GA063 SA and GA040 D; □ 5mm/0.2" ❶	1	0.050
GAX60 01	For GA063 A...GA125 A, □ 7mm/0.3" ❷❸	1	0.075

- ❶ Use GAX7... shaft extensions.
- ❷ Use GAX66.. handles and GAX7...A extensions for a door coupling version.
- ❸ Cannot be used with GA160A.

Operational characteristics of auxiliary contacts

- Conventional free air thermal current Ith: 10A
- UL/CSA and IEC/EN 60947-5-1 designation: A600-Q600
- Tightening torque: 0.8Nm/7.1lbin.

Operational characteristics for other devices

- Tightening torque:
 - GAX31A/C-GAX33A/C terminals: 1.8...2Nm/16...18lbin
 - GAX32A/C-GAX34A/C terminals: 5...6Nm/45...54lbin
 - GAX5000/1-GAX6000/1 fixing: 0.5Nm/4.4lbin; extension with handle: 0.8Nm/7.1lbin.

Transformation of direct operating version into door coupling type

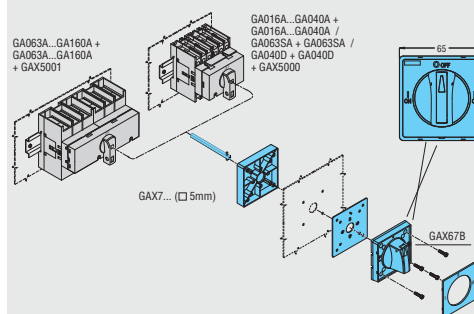

Certifications and compliance

Certifications obtained:

Type	cULus according to UL508 / CSA C22.2 no. 14	cULus according to UL98A / CSA C22.2 no. 4	EAC
GAX10 11A - GAX10 11C	●	—	●
GAX11 10EA	●	—	●
GAX12 10EA	●	—	●
GAX31 A - GAX31 C	●	—	●
GAX32 A - GAX32 C	—	●	●
GAX33 A - GAX33 C	●	—	●
GAX34 A - GAX34 C	—	●	●
GAX50 00 - GAX60 00	●	—	●
GAX50 01 - GAX60 01	—	●	●

● Certification obtained.

Compliant with standards: IEC/EN 60947-1, IEC/EN 60947-3, IEC/EN 60947-5-1, UL508, UL98A, CSA C22.2.

Strokes of GA poles (main poles with auxiliary contacts)

	Travel 0→1	0°	30°	60°	90°
GA016A/C...GA040A/C - GA063SA	Main poles			60°	
GAX10 11A - GAX10 11C	Auxiliary contacts (1NO+1NC)			60°	
	NO				
	NC				
GAX11 10EA	auxiliary contact (1EB NO early-break with respect to main poles)		40°	60°	
	Travel 0→1				
	Travel 1→0			70°	
GA063A/C...GA125A/C, GA160A	Main poles			55°	
GAX10 11A - GAX10 11C	Auxiliary contacts (1NO+1NC)			45°	
	NO				
	NC				
GAX12 10EA	auxiliary contact (1EB NO early-break with respect to main poles)		25°	55°	
	Travel 0→1				
	Travel 1→0			65°	

Strokes of GA...D types (main poles and auxiliary contacts)

	Corsa 0→1	0°	30°	60°	90°
GA040 D	Main poles			60°	
GA042 040D	simultaneous closing fourth -pole add on			60°	
GAX10 11A	Auxiliary contacts (1NO+1NC)			60°	
	NO				
	NC				
GAX11 10EA	auxiliary contact (1EB NO early-break with respect to main poles)		40°	60°	
	Travel 0→1				
	Travel 1→0			70°	

Maximum combinations

GA016 A...GA040 A Sequence and maximum combination of add-on blocks on direct operating switch disconnectors.
GA040 D

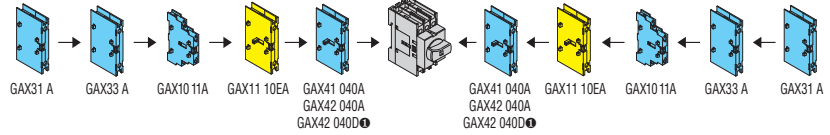

1	1	1	—	1	GA016 A GA025 A GA032 A GA040 A	—	—	2	1	1	
1	1	2	—	—		1	—	1	1	1	
1	1	1	—	1		—	1	1	1	1	
1	1	1	1	—		1	—	2	1	1	
1	1	1	2	—		—	—	1	1	1	
1	1	2	—	—		—	—	2	1	1	
1	1	—	—	—		GA040 D	1	—	—	1	1
1	1	—	—	1		—	—	—	1	1	1
1	1	—	—	—		—	—	—	—	1	1
1	1	—	—	—		—	—	—	—	1	1

1 GAX42 040D can be used with GA040 D switch only.

GA063 SA

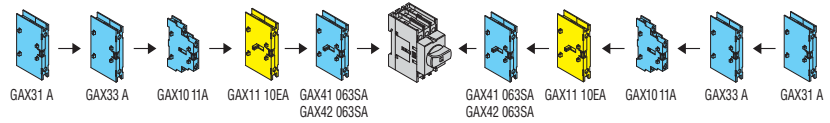

1	1	1	—	1	GA063 SA	—	—	2	1	1
1	1	2	—	—		1	—	1	1	1
1	1	1	—	1		—	—	1	1	1
1	1	1	1	—		1	—	1	1	1
1	1	1	1	—		—	—	2	1	1
1	1	1	2	—		—	—	1	1	1
1	1	2	—	—		—	—	2	1	1
1	1	—	—	—		—	1	—	1	1
1	1	—	—	1		—	—	—	1	1
1	1	—	—	—		—	—	—	1	1

GA063 A...GA160 A

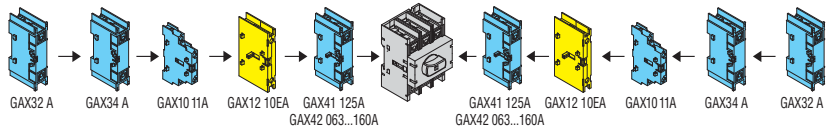

—	—	1	—	1	GA063 A GA080 A GA100 A GA125 A GA160 A	—	—	2	—	—	
—	—	2	—	—		1	—	1	—	—	
—	—	1	—	1		—	—	1	—	—	
—	—	1	1	—		—	1	—	—	—	
—	—	1	1	—		—	—	2	—	—	
—	—	2	—	—		—	—	1	1	—	
—	—	2	—	—		—	—	2	—	—	
1	1	—	—	—		—	1	—	—	1	1
1	1	—	—	1		—	—	—	1	1	1
1	1	—	—	—		—	—	—	1	1	1

1 GA160 A can be fitted with 1 single 4th pole (GAX42160 A) on one side and an auxiliary contact on the other.

GA016 C...GA040 C Sequence and maximum combination of add-on blocks on door mount switch disconnectors.

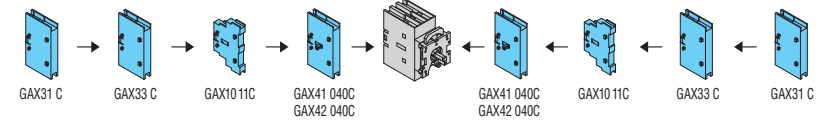

1	1	1	1	GA016 C GA025 C GA032 C GA040 C	—	1	1	1
1	1	1	—		1	1	1	1
1	1	1	—		—	—	1	1
1	1	1	—		—	—	1	1
1	1	1	—		—	—	1	1
1	1	—	—		—	—	—	1

GA063 C...GA125 C

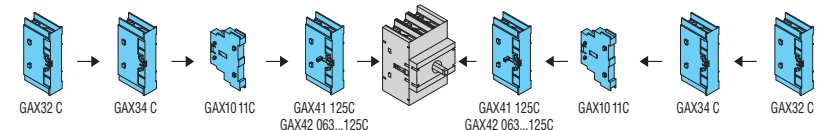

—	—	1	—	1	GA063 C GA080 C GA100 C GA125 C	—	1	—	—	
—	—	1	—	—		1	—	1	—	—
1	1	—	—	1		—	—	1	—	—
—	—	1	—	—		—	1	—	1	1
—	—	1	—	—		—	—	1	—	—
1	1	—	—	—		—	—	—	1	1

Maximum combinations

GA016 A...GA040 A
GA040 D
+ GAX50 00 -
GAX60 00

Sequence and maximum combination for mechanical coupling and mechanical interlock for line changeover.

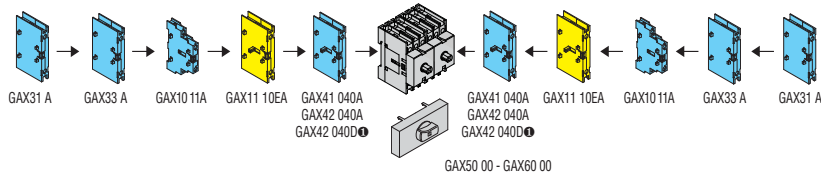

1	1	1	—	1	GA016 A + GA016 A	1	—	1	1	1	
1	1	1	—	1		GA025 A + GA025 A	—	—	2	1	1
1	1	2	—	—			1	—	1	1	1
1	1	1	—	1		GA032 A + GA032 A	—	1	1	1	1
1	1	1	1	—			1	—	2	1	1
1	1	2	—	—		GA040 A + GA040 A	—	1	1	1	1
1	1	2	—	—			—	—	2	1	1
1	1	—	—	1		GA040 D + GA040 D ①	1	—	—	1	1
1	1	—	—	—			—	—	—	1	1

① GAX42 040D can be used with GA040 D switch only.

GA063 SA
+ GAX50 00 -
GAX60 00

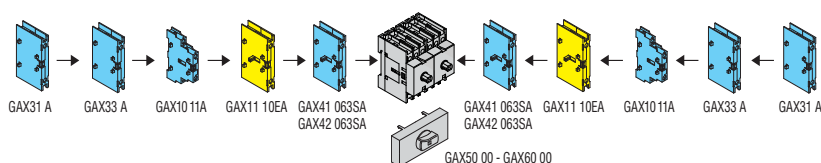

1	1	1	—	1	GA063SA + GA063SA	1	—	1	1	1
1	1	1	—	1		—	—	2	1	1
1	1	2	—	—		1	—	1	1	1
1	1	1	—	1		—	1	—	1	1
1	1	1	1	—		—	—	2	1	1
1	1	2	—	—		—	1	1	1	1
1	1	2	—	—		—	—	2	1	1
1	1	—	—	1		1	—	—	1	1
1	1	—	—	—		—	—	—	1	1

GA063 A...GA160 A
+ GAX50 01 -
GAX60 01

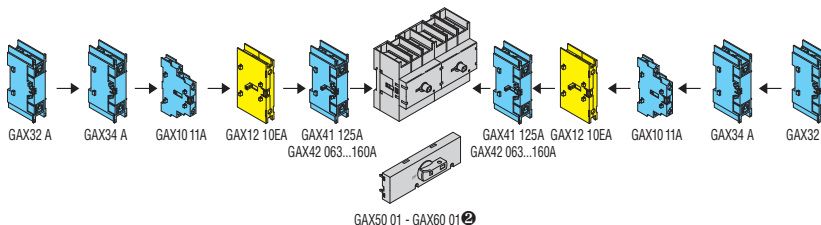

—	—	1	—	1	GA063 A + GA063 A	1	—	1	—	—	
—	—	1	—	1		GA080 A + GA080 A	—	—	2	—	—
—	—	2	—	—			1	—	1	—	—
—	—	1	—	1		GA100 A + GA100 A	—	1	1	—	—
—	—	1	1	—			—	—	2	—	—
—	—	2	—	—		GA125 A + GA125 A	—	1	1	—	—
—	—	2	—	—			—	—	2	—	—
1	1	—	—	1		GA160 A + GA160 A ①	1	—	—	1	1
1	1	—	—	—			—	—	—	1	1

① GA160A can be fitted with a single auxiliary contact (GAX1011A) per side.

② Cannot be used with GA160A

Handles



GAX61



GAX62

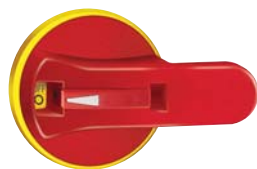

GAX66



GAX68



GAX63 B



GAX63 2B
Low profile



GAX67 B

new

new

Order code	Characteristics	Qty per pkg	Wt [kg]
DOOR COUPLING VERSION PADLOCKABLE, IP65 (4X). Red/yellow.			
GAX61	For GA...A, GA063 SA, GA...C, GA040 D and GD... Screw fixing. Handle with selector flush-mounted ①. □ 5mm/0.2"	1	0.073
GAX62	For GA...A, GA063 SA, GA...C, GA040 D and GD... Screw fixing. Handle with selector protruding ①. □ 5mm/0.2"	1	0.072
GAX63	For GA...A, GA063 SA, GA016 C... GA040 C, GA040 D and GD... Ring fixing. Handle with selector protruding ①②. □ 5mm/0.2"	1	0.068
GAX63 2	Per GA...A, GA063 SA, GA040 D and GD... Ring fixing lowered. Handle with selector protruding. □ 5mm/0.2" ①	1	0.057
GAX64	For GA...A, GA063 SA, GA040 D and GD... Ring fixing. Handle with selector protruding - defeatable (requirement UL508A)①. □ 5mm/0.2"	1	0.064
GAX66	For GA063 A...GA160 A, and GAX60 01. Screw fixing. Pistol handle - defeatable (req. UL 508A)③. □ 7mm/0.3"	1	0.140
GAX68	For GA016 A...GA063 SA, GA040 D, GA016 C...GA040 C and GD... Screw fixing. Handle with selector lowered ①. □ 5mm/0.2"	1	0.060

Black.			
GAX61 B	For GA...A, GA063 SA, GA...C, GA040 D and GD... Screw fixing. Handle with selector flush-mounted ①. □ 5mm/0.2"	1	0.073
GAX62 B	For GA...A, GA063 SA, GA...C, GA040 D and GD... Screw fixing. Handle with selector protruding ①. □ 5mm/0.2"	1	0.072
GAX63 B	For GA...A, GA063 SA, GA016 C... GA040 C, GA040 D and GD... Ring fixing. Handle with selector protruding ①②. □ 5mm/0.2"	1	0.068
GAX63 1B	For GA...A, GA063 SA, GA016 C... GA040 C, GA040 D and GD... Ring fixing. Handle with selector protruding padlockable in ON pos. (UNI 9490 and UNI EN 12845) ①②. □ 5mm/0.2"	1	0.074
GAX63 2B	For GA...A, GA063 SA, GA040 D and GD... Ring fixing lowered. Handle with selector protruding. □ 5mm/0.2" ①	1	0.057
GAX64 B	For GA...A, GA063 SA, GA040 D and GD... Ring fixing. Handle with selector protruding - defeatable (requirement UL508A)①. □ 5mm/0.2"	1	0.064
GAX66 B	For GA063 A...GA160 A and GAX60 01. Screw fixing. Pistol handle - defeatable (req. UL 508A)③. □ 7mm/0.3"	1	0.140
GAX67 B	For mechanical interlock GAX50... (I-O-II)①. □ 5mm/0.2"	1	0.078
GAX68 B	For GA016 A...GA063 SA, GA040 D, GA016 C...GA040 C and GD... Screw fixing. Handle with selector lowered ①. □ 5mm/0.2"	1	0.060

ACCESSORIES FOR DOOR COUPLING CONTROL For GAX66 and GAX66 B handles.			
GAX60 B	Adaptor □ 7mm/0.3" per GA063 A...GA160 A	1	0.010

General and operational characteristics

- Choice of handle fixing: ring or screw
- Fixing handle interaxis:
 - GAX61/61B-GAX62/62B-GAX67B: 36x36mm/1.42x1.42" or 48x48mm/1.89x1.89"
 - GAX66/66B: 36x36mm/1.42x1.42"
 - GAX68/68B: 28x28mm/1.10x1.10" or 36x36mm/1.42x1.42"
- Compatible with pre-existing drillings of most common types in the marketplace
- 1 to 3 padlocks in the Ø4...8mm/0.16...0.31" for all handles (except GAX68 only one Ø4...8mm/0.16...0.31")
- Front plate dimensions:
 - GAX61/61B-GAX62/62B-GAX63/63B-GAX64/64B-GAX67/67B: 65x65mm/2.56x2.56"
 - GAX66/66B: Ø75mm/2.95"
 - GAX68/68B: 48x48mm/1.89x1.89"
- Tightening torque:
 - Fixing ring types: 2.3Nm/20.4lbin
 - GAX60B: 0.8Nm/7lbin
 - GAX66/66B: 1.5Nm/13.3lbin
 - All others: 1Nm/9lbin
- Degree of protection for all: IP65
- Degree of protection for GAX66/66B: IP66; for UL/CSA data see detail on page 11-10.

Certifications and compliance

Certifications obtained: cULUS for GAX68. See the table on page 11-10.

① For GA...A and GA040 D switch disconnectors, separately purchase extension GAX7...
 ② Snap-on fixing of GA016 C...GA040 C switch disconnectors with the handle.
 ③ Separately purchase GAX7...A shaft extension and GAX60 B handle having a 7mm square section, not required for GAX60 01.

Transformation of direct operating version into door coupling version

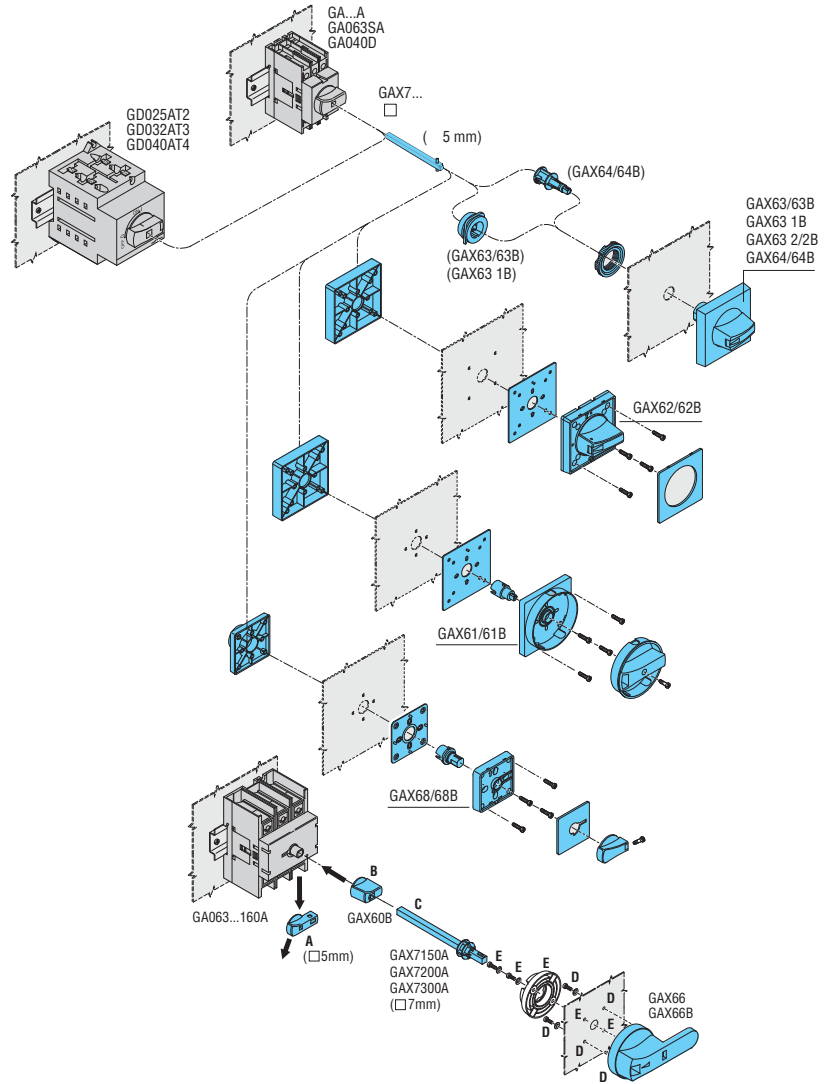

Door mount version

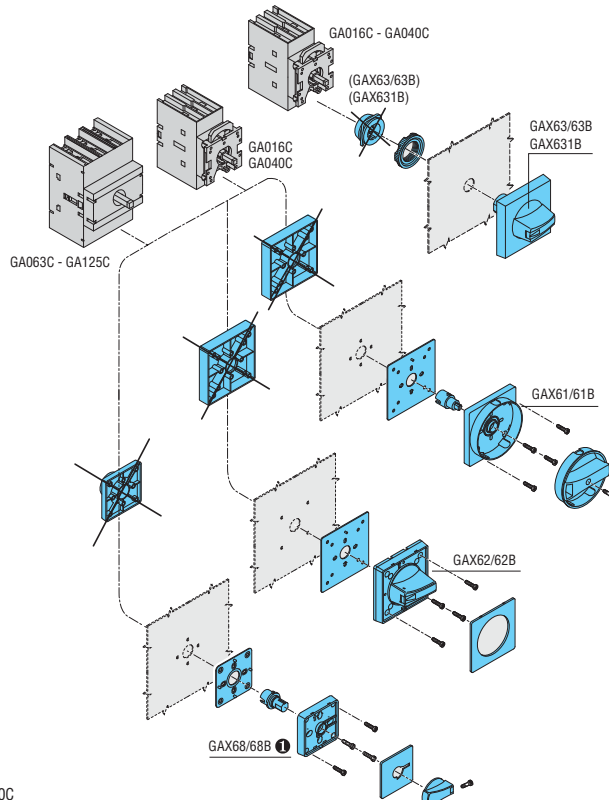

① Only for GA016C...GA040C

Shaft extensions Terminal covers Fuse holders/blocks



GAX7...



GAX7... A

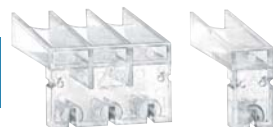

GAX8...



GAX39 1

Order code	Characteristics	Qty per pkg	Wt
		n°	[kg]

Shaft extension for door coupling handles GAX61...GAX64, GAX68, GAX61 B...GAX64 B, GAX67 B, GAX68 B and mechanical interlock type GAX50 00, GAX50 01 and mechanical coupling GAX60 00.

GAX7 055	55mm/2.16" long □ 5mm/0.2"	1	0.012
GAX7 070	70mm/2.75" long □ 5mm/0.2"	1	0.014
GAX7 090	90mm/3.54" long □ 5mm/0.2"	1	0.018
GAX7 150	150mm/5.90" long □ 5mm/0.2"	1	0.032
GAX7 200	200mm/7.87" long □ 5mm/0.2"	1	0.070
GAX7 300	300mm/11.81" long □ 5mm/0.2"	1	0.068
GAX7 400	400mm/15.75" long □ 5mm/0.2"	1	0.072
GAX7 500	500mm/19.68" long □ 5mm/0.2"	1	0.090

Shaft extension for door coupling handles GAX66, GAX66 B and mechanical coupling system GAX60 01.

GAX7 150A	150mm/5.90" long □ 7mm/0.3"	1	0.090
GAX7 200A	200mm/7.87" long □ 7mm/0.3"	1	0.112
GAX7 300A	300mm/11.81" long □ 7mm/0.3"	1	0.160

Set of 2 one-pole terminal covers for fourth pole.

GAX81	For GAX42 040A, GAX42 063SA, GAX42 040C, GAX42 040D, GAX41 040A, GAX41 063A and GAX41 040C	1	0.009
GAX82	For GAX42 063A...GAX42 160A	1	0.012

Set of 2 three-pole terminal covers.

GAX83	For GA016 A...GA040 A, GA063 SA, GA016 C...GA040 C and GA040 D	1	0.011
GAX84	For GA063 A...GA160 A, GA063 C...GA125 C	1	0.030

Fuse holder for switch disconnectors.

GAX39 1	For GA016 A...GA032 A Suitable for 10.3x38 fuse size	1	0.132
GAX39 1UL	For GA016 A...GA025 A Suitable for Class CC fuses	1	0.135

Operational characteristics of fuse holder

- IEC rated insulation voltage Ui: 1000V
- IEC rated impulse withstand Uimp: 8kV
- The fuse holder/blocks connects directly to the switch disconnectors
- Access to fuses only when the switch disconnectors are in OFF position.

Terminal covers

For switch disconnectors

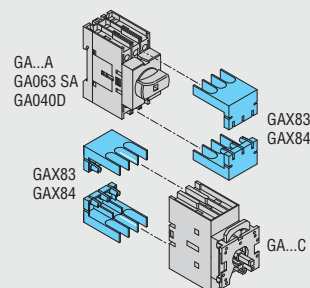

For fourth pole

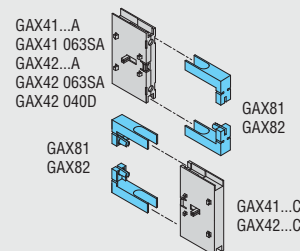

Certifications and compliance

Certifications obtained:

Type	cULus according to UL508 / CSA C22.2 no. 14	cULus according to UL98A / CSA C22.2 no. 4	EAC
GAX61-GAX61 B	●	●	●
GAX62-GAX62 B	●	●	●
GAX63-GAX63 B	●	●	●
GAX63 1B	—	—	●
GAX63 2-GAX63 2B	●	●	●
GAX64-GAX64 B	●	●	●
GAX66-GAX66 B	—	●	●
GAX67 B	●	—	●
GAX68-GAX68 B	●	—	●
GAX60 B	—	●	●
GAX7 055...GAX7 500	●	●	●
GAX7 150A ... GAX7 300A	—	●	●
GAX81-GAX83	●	—	●
GAX82-GAX84	—	●	●
GAX39 1	—	—	●
GAX39 1UL	●	—	—

● Certification obtained.

NOTE: Types GAX62/62B, GAX63/63B, GAX 632/2B, GAX64/64B, GAX68/68B, GX67 are UL/CSA Type 1, 2, 3R, 12, 12K, 4, 4X external use when used with types GA016...40A/C, GA040D and GA063SA while with GA063...GA125A/C, only UL/CSA Type 1. Types GAX61/61B and GAX66/66B are UL/CSA Type 1, 4, 4X external use with all GA types.

Compliant with standards: IEC/EN 60947-1, IEC/EN 60947-3, UL508, UL98A, CSA C22.2.

Empty enclosures IEC/EN IP65 type



GAZ1

GAZ2



GAZ3



GAX30

new

Order code	Description	Qty per pkg	Wt
		n°	[kg]

For switch disconnectors.
With red/yellow handle. Complete with shaft extension.

GAZ1	For GA016 A...GA040 A/D	1	0.320
GAZ2	For GA063 SA, GA063 A...GA100 A	1	0.780
GAZ3	For GA125 A...GA160 A	1	1.900

With black handle. Complete with shaft extension.

GAZ1 B	For GA016 A...GA040 A/D	1	0.320
GAZ2 B	For GA063 SA, GA063 A...GA100 A	1	0.730
GAZ3 B	For GA125 A...GA160 A	1	1.900

Accessory.

GAX 30	Shielded cable fixing kit for GAZ1 and GAZ1B	1	0.083
---------------	--	---	-------

The empty enclosures are supplied with the following accessories:

Enclosure	GAZ1 GAZ1B	GAZ2 GAZ2B	GAZ3 GAZ3B
Red/yellow handle	GAX61	GAX61	GAX61
Black handle	GAX61B	GAX61B	GAX61B
Extension	1	1	1
Neutral plate terminal	1	1	-
Earth/Ground plate terminal	1	1	-

General characteristics

- Enclosure material: ABS
- For four-pole types not indicated, separately purchase corresponding fourth pole GAX42...A and install on enclosed 3-pole version
- Possible accessories to mount afterwards, if any required:
 - GAX30 to provide shielded cable connection continuity (e.g. with static converters)
 - GAZ016...GAZ040...: 1 contact block both on the right and left disconnector side unless 4th pole is installed
 - Other types: 2 contact blocks both on the right and left disconnector side unless 4th pole is installed
 - GAZ125...GAZ160...: if any earth/ground and/or neutral terminal required, separately purchase types GAX3... given on page 11–5.
- Padlockable handles
- Sealable cover
- Tightening torque for cover screws:
 - GAZ016...GAZ040... and GAZ1...: 1.3Nm/16lbin
 - Other types: 1.5Nm/13lbin
- Degree of protection: IP65
- Cable entry:
 - GAZ016..., GAZ040... and GAZ1... types: PG16/M25 and PG13.5/M20 knockouts
 - GAZ063SA...GAZ100... and GAZ2... types: PG16/M25 and PG29/M32 knockouts
 - GAZ125..., GAZ160... and GAZ3 types: Smooth surfaces; can be drilled by customer.

Certifications and compliance

Certifications obtained: EAC
Compliant with standards: IEC/EN 60947-3, IEC/EN 60947-1.

Empty enclosures UL/CSA Type 4/4X



GAZ1 UL



GAZ2 UL



GAX30

new

Order code	Description	Qty per pkg	Wt
		no.	[kg]

For switch disconnectors.
With red/yellow handle. Complete with shaft extension.

GAZ1 UL	For GA016 A...GA040 A and GA040 D	1	0.320
GAZ2 UL	For GA063 SA	1	0.730

With black handle. Complete with shaft extension.

GAZ1 B UL	For GA016 A...GA040 A and GA040 D	1	0.320
GAZ2 B UL	For GA063 SA	1	0.730

Accessory.

GAX 30	Shielded cable fixing kit for GAZ1UL and GAZ1BUL	1	0.083
---------------	--	---	-------

The empty enclosures are supplied with the following accessories:

Enclosure	GAZ1UL GAZ1BUL	GAZ2UL GAZ2BUL
Red/yellow handle	GAX61	GAX61
Black handle	GAX61B	GAX61B
Extension	1	1
Neutral plate terminal	1	1
Earth/Ground plate terminal	1	1

General characteristics

- Enclosure material: Polycarbonate
- For four-pole types not indicated, separately purchase corresponding fourth pole GAX4...A and install on enclosed 3-pole UL-suffix version
- Possible accessories to mount afterwards, if any required:
 - GAX30 to provide shielded cable connection continuity (e.g. with static converters)
 - GAZ016...GAZ040...: 1 contact block both on the right and left disconnector side unless 4th pole is installed
 - Other types: 2 contact blocks both on the right and left disconnector side unless 4th pole is installed
- Padlockable handles
- Sealable cover
- Tightening torque for cover screws:
 - GAZ016...GAZ040...UL and GAZ1...UL: 1.3Nm/16lbin
 - Other types: 1.5Nm/13lbin
- Degree of protection: IP65; UL/CSA Type 4/4X
- Cable entry:
 - GAZ016...GAZ040...UL and GAZ1...UL types: PG16/M25 and PG13.5/M20 knockouts
 - GAZ063SA...UL and GAZ2...UL types: PG16/M25 and PG29/M32 knockouts
 - GAZ063...GAZ125...UL types: Smooth surfaces; can be drilled by customer.

Certifications and compliance

Certifications obtained: EAC for all; cULus for GAZ016...GAZ125...UL, GAZ1...UL and GAZ2...UL types.
Compliant with standards: IEC/EN 60947-3, IEC/EN 60947-1, UL 508 and CSA C22.2 no. 14 (up to GAZ063SA...), UL98A and CSA C22.2 n° 4 (for all others).

IEC/EN IP65 non-metallic enclosure



GAZ016...GAZ040...



GAZ063...100 C



GAZ125... GAZ160...

Order code	IEC conventional free air thermal current Ith AC21A (≤690V)	Qty per pkg	Wt
	[A]	n°	[kg]

THREE POLE.
With red/yellow handle.

GAZ016	16	1	0.450
GAZ025	25	1	0.450
GAZ032	32	1	0.450
GAZ040	40	1	0.450
GAZ063 SA	63	1	0.870
GAZ063 C	63	1	1.220
GAZ080 C	80	1	1.220
GAZ100 C	100	1	1.220
GAZ125	125	1	2.220
GAZ160	160	1	2.220

new

THREE POLE.
With black handle.

GAZ016 B	16	1	0.450
GAZ025 B	25	1	0.450
GAZ032 B	32	1	0.450
GAZ040 B	40	1	0.450
GAZ063 SAB	63	1	0.870
GAZ063 CB	63	1	1.220
GAZ080 CB	80	1	1.220
GAZ100 CB	100	1	1.220
GAZ125 B	125	1	2.220
GAZ160 B	160	1	2.220

new

FOUR POLE.
With red/yellow handle.

GAZ016 T4	16	1	0.550
GAZ032 T4	32	1	0.550
GAZ040 T4	40	1	0.550
GAZ063 SAT4	63	1	0.780
GAZ063 CT4	63	1	1.250
GAZ100 CT4	100	1	1.250
GAZ125 T4	125	1	2.500
GAZ160 T4	160	1	2.500

new

FOUR POLE.
With black handle.

GAZ016 T4B	16	1	0.550
GAZ032 T4B	32	1	0.550
GAZ040 T4B	40	1	0.550
GAZ063 SAT4B	63	1	0.780
GAZ063 CT4B	63	1	1.250
GAZ100 CT4B	100	1	1.250
GAZ125 T4B	125	1	2.500
GAZ160 T4B	160	1	2.500

new

Components Enclosure	Switch disconnector	Handle
GAZ1	GA016 A	GAX61
GAZ1	GA025 A	GAX61
GAZ1	GA032 A	GAX61
GAZ1	GA040 A	GAX61
GAZ2	GA063 SA	GAX61
GAZ2	GA063 A	GAX61
GAZ2	GA080 A	GAX61
GAZ2	GA100 A	GAX61
GAZ3	GA125 A	GAX61
GAZ3	GA160 A	GAX61

GAZ1 B	GA016 A	GAX61 B
GAZ1 B	GA025 A	GAX61 B
GAZ1 B	GA032 A	GAX61 B
GAZ1 B	GA040 A	GAX61 B
GAZ2 B	GA063 SA	GAX61 B
GAZ2 B	GA063 A	GAX61 B
GAZ2 B	GA080 A	GAX61 B
GAZ2 B	GA100 A	GAX61 B
GAZ3 B	GA125 A	GAX61 B
GAZ3 B	GA160 A	GAX61 B

Enclosure	Switch disconnector	4th pole	Handle
GAZ1	GA016 A	GAX42040A	GAX61
GAZ1	GA032 A	GAX42040A	GAX61
GAZ1	GA040 A	GAX42040A	GAX61
GAZ2	GA063 SA	GAX42063SA	GAX61
GAZ2	GA063 A	GAX42063A	GAX61
GAZ2	GA100 A	GAX42100A	GAX61
GAZ3	GA125 A	GAX42125A	GAX61
GAZ3	GA160 A	GAX42160A	GAX61

GAZ1 B	GA016 A	GAX42040A	GAX61 B
GAZ1 B	GA032 A	GAX42040A	GAX61 B
GAZ1 B	GA040 A	GAX42040A	GAX61 B
GAZ2 B	GA063 SA	GAX42063SA	GAX61 B
GAZ2 B	GA063 A	GAX42063A	GAX61 B
GAZ2 B	GA100 A	GAX42100A	GAX61 B
GAZ3 B	GA125 A	GAX42125A	GAX61 B
GAZ3 B	GA160 A	GAX42160A	GAX61 B

Switch disconnectors

GA series 16A to 160A

Enclosed switch disconnectors

UL/CSA Type 4/4X non-metallic enclosure



GAZ016...GAZ040...UL



GAZ063 SA UL



GAZ063 UL - GAZ125 UL

UL/CSA ratings

Type	1 phase [HP]		3 phase [HP]				General use at 600VAC [A]	Short-circuit rating at 600VAC [kA]	Fuse class - max rating at 600V Type - [A]
	120V	240V	200-208V	240V	480V	600V			
GAZ016...	1	2	5	5	10	10	16	5	RK5 - 20A
GAZ025...	1½	3	7½	7½	15	20	25	5	RK5 - 30A
GAZ032...	2	5	10	10	20	20	32	5	RK5 - 35A
GAZ040...	2	5	10	15	20	25	40	5	RK5 - 45A
GAZ063S...	2	7½	10	15	30	30	60	5	RK5 - 45A

NOTE: Above ratings are valid for GAZ016 - GAZ063S...UL types, according to UL508 and CSA 22.2 n°14.
UL Listed for USA and Canada (cULus - File E93602), as Manual Motor Controllers while UL designation is "GENERAL PURPOSE SWITCH. INTERRUPTEUR USAGE GENERAL" and "SUITABLE AS MOTOR DISCONNECT"; GAZ063S... pending.

Type	1 phase [HP]		3 phase [HP]				General use at 600VAC [A]	Short-circuit rating at 600VAC [kA]	Max fuse rating at 600V [A]
	120V	240V	200-208V ^②	240V	480V	600V			
① GAZ063C...	3	7½	20	20	40	40	60	10	100
GAZ080...	3	10	25	25	40	40	100	10	100
GAZ100...	5	10	30	30	50	50	100	10	100
GAZ125...	7½	10	30	30	60	60	100	10	100

NOTE: Above ratings are valid for GAZ063C - GAZ125... types, according to UL98 and CSA C22.2 n°4.

For indication and reference purposes only while cCSAus is pending.

① Lower ratings in this same UL/CSA category are available on specific request for volume orders.

For information, consult Customer Service; see contact details on inside front cover.

② Voltage value not considered in UL98 / CSA 22.2 n°4 standards.

Order code	IEC conventional free air thermal current Ith AC21A (≤690V) [A]	Qty per pkg n°	Wt [kg]
------------	---	----------------	---------

THREE POLE.
With red/yellow handle.

GAZ016 UL	16	1	0.450
GAZ025 UL	25	1	0.450
GAZ032 UL	32	1	0.450
GAZ040 UL	40	1	0.450
GAZ063 SA UL	63	1	0.870
GAZ063 UL	63	1	1.220
GAZ080 UL	80	1	2.220
GAZ100 UL	100	1	2.220
GAZ125 UL	125	1	2.220

THREE POLE.
With black handle.

GAZ016 B UL	16	1	0.450
GAZ025 B UL	25	1	0.450
GAZ032 B UL	32	1	0.450
GAZ040 B UL	40	1	0.450
GAZ063 SAB UL	63	1	0.870
GAZ063 B UL	63	1	1.220
GAZ080 B UL	80	1	2.220
GAZ100 B UL	100	1	2.220
GAZ125 B UL	125	1	2.220

FOUR POLE.
With red/yellow handle.

GAZ016 T4 UL	16	1	0.550
GAZ032 T4 UL	32	1	0.550
GAZ063 T4 UL	63	1	1.150
GAZ100 T4 UL	100	1	2.500
GAZ125 T4 UL	125	1	2.500

FOUR POLE.
With black handle.

GAZ016 T4B UL	16	1	0.550
GAZ032 T4B UL	32	1	0.550
GAZ063 T4B UL	63	1	1.150
GAZ100 T4B UL	100	1	2.500
GAZ125 T4B UL	125	1	2.500

Components

Enclosure	Switch disconnector	Handle
GAZ1 UL	GA016 A	GAX61
GAZ1 UL	GA025 A	GAX61
GAZ1 UL	GA032 A	GAX61
GAZ1 UL	GA040 A	GAX61
GAZ2 UL	GA063 SA	GAX61
GAZ3 ①	GA063 A	GAX61
GAZ3 ①	GA080 A	GAX61
GAZ3 ①	GA100 A	GAX61
GAZ3 ①	GA125 A	GAX61

GAZ1 B UL	GA016 A	GAX61 B
GAZ1 B UL	GA025 A	GAX61 B
GAZ1 B UL	GA032 A	GAX61 B
GAZ1 B UL	GA040 A	GAX61 B
GAZ2 B UL	GA063 SA	GAX61 B
GAZ3 B ①	GA063 A	GAX61 B
GAZ3 B ①	GA080 A	GAX61 B
GAZ3 B ①	GA100 A	GAX61 B
GAZ3 B ①	GA125 A	GAX61 B

Enclosure	Switch disconnector	4th pole	Handle
GAZ1 UL	GA016 A	GAX42040A	GAX61
GAZ1 UL	GA032 A	GAX42040A	GAX61
GAZ3 ①	GA063 A	GAX42063A	GAX61
GAZ3 ①	GA100 A	GAX42100A	GAX61
GAZ3 ①	GA125 A	GAX42125A	GAX61

GAZ1 B UL	GA016 A	GAX42040A	GAX61 B
GAZ1 B UL	GA032 A	GAX42040A	GAX61 B
GAZ3 B ①	GA063 A	GAX42063A	GAX61 B
GAZ3 B ①	GA100 A	GAX42100A	GAX61 B
GAZ3 B ①	GA125 A	GAX42125A	GAX61 B

① For major details contact our Customer Service office; see contact details on inside front cover.

Switch disconnectors

GA series 16A to 160A

Enclosed changeover switches

UL/CSA Type 4/4X non-metallic enclosure



GAZ 025 E...GAZ 063SA E...



GAZ 080 E...
GAZ 160 E...

Order code	IEC conventional free air thermal current Ith		IEC rated operational current Ie		Qty per pkg	Wt
	AC21A (≤690V)		AC23B (≤400V)	AC23B (≤500V)		
	[A]		[A]	[A]	n°	[kg]

3-pole line changeover switches I-0-II.

GAZ025 ET6	25	25	25	1	1.060
GAZ040 ET6	40	40	25	1	1.060
GAZ063SA ET6	63	45	25	1	1.070
GAZ080 ET6	80	80	63	1	2.950
GAZ125 ET6	125	125	100	1	2.950
GAZ160 ET6	160	125	100	1	2.950

4-pole line changeover switches I-0-II.

GAZ025 ET8	25	25	25	1	1.060
GAZ040 ET8	40	40	25	1	1.060
GAZ063SA ET8	63	45	25	1	1.070
GAZ080 ET8	80	80	63	1	2.950
GAZ125 ET8	125	125	100	1	2.950
GAZ160 ET8	160	125	100	1	2.950

Components

Enclosure	Switch disconnectors	Interlock	Handle
GAZ UL ❶	2x GA025A	GAX5000	GAX67 B
GAZ UL ❶	2x GA040A	GAX5000	GAX67 B
GAZ UL ❶	2x GA063SA	GAX5000	GAX67 B
GAZ3 ❶	2x GA080A	GAX5001	GAX67 B
GAZ3 ❶	2x GA125A	GAX5001	GAX67 B
GAZ3 ❶	2x GA160A	GAX5001	GAX67 B
Enclosure	Switch disconnectors	Interlock	Handle
GAZ UL ❶	2x GA025A + 2x GAX42040A	GAX5000	GAX67 B
GAZ UL ❶	2x GA040A+ 2x GAX42040A	GAX5000	GAX67 B
GAZ UL ❶	2x GA063SA+ 2x GAX42063SA	GAX5000	GAX67 B
GAZ3 ❶	2x GA080A+ 2x GAX42080A	GAX5001	GAX67 B
GAZ3 ❶	2x GA125A+ 2x GAX42125A	GAX5001	GAX67 B
GAZ3 ❶	2x GA160A+ 2x GAX42160A	GAX5001	GAX67 B

❶ For major details contact our Customer Service office; see contact details on inside front cover.

General characteristics

- Enclosure material: Polycarbonate
- Possibility of fitting:
 - 2 contact blocks both on the right and left side for GAZ...ET6 types
 - 1 contact block both on the right and left side for GAZ...ET8 types
- Padlockable handle complete with extension
- Earth and neutral plate terminals
- Sealable enclosure cover
- Tightening torque for cover screws: 1.5Nm/13lbin
- Degree of protection: IP65; UL/CSA type 4/4X
- Cable entry:
 - GAZ025...GAZ063SA... types: PG16/M25 and PG29/M32 knockouts
 - GAZ080... and GAZ160... types: Smooth surfaces; can be drilled by customer.

Certifications and compliance

Certifications obtained: cULus (except GAZ160E...), EAC. Compliant with standards: IEC/EN 60947-3, IEC/EN 60947-1, UL 508 and CSA C22.2 no. 14 (up to GAZ063SA...), UL98A and CSA C22.2 no. 4 (for all others except GAZ160E...).

UL/CSA ratings

Type	1 phase [HP]		3 phase [HP]				General use at 600VAC	Short-circuit rating at 600VAC	Fuse class - max rating at 600V
	120V	240V	200-208V	240V	480V	600V			
GAZ025...	1½	3	7½	7½	15	20	25	5	RK5 - 30A
GAZ040...	2	5	10	15	20	25	40	5	RK5 - 45A
GAZ063S...	2	7½	10	15	30	30	60	5	RK5 - 45A

NOTE: Above ratings are valid for GAZ025-GAZ040ET... types, according to UL508 and CSA 22.2 n°14. For indication and references purposes only while cCSAus is pending.

Type	1 phase [HP]		3 phase [HP]				General use at 600VAC	Short-circuit rating at 600VAC	Max fuse rating at 600V
	120V	240V	200-208V❶	240V	480V	600V			
GA080...	3	10	25	25	40	40	100	10	100
GA125...	7½	10	30	30	60	60	100	10	100

NOTE: Above ratings are valid for GAZ080-GAZ125ET... types, according to UL98 and CSA C22.2 n°4. For indication and references purposes only while cCSAus is pending.

❶ Voltage value not considered in UL98 / CSA 22.2 n°4 standards so not indicated in UL product marking.

Maximum combination Enclosures

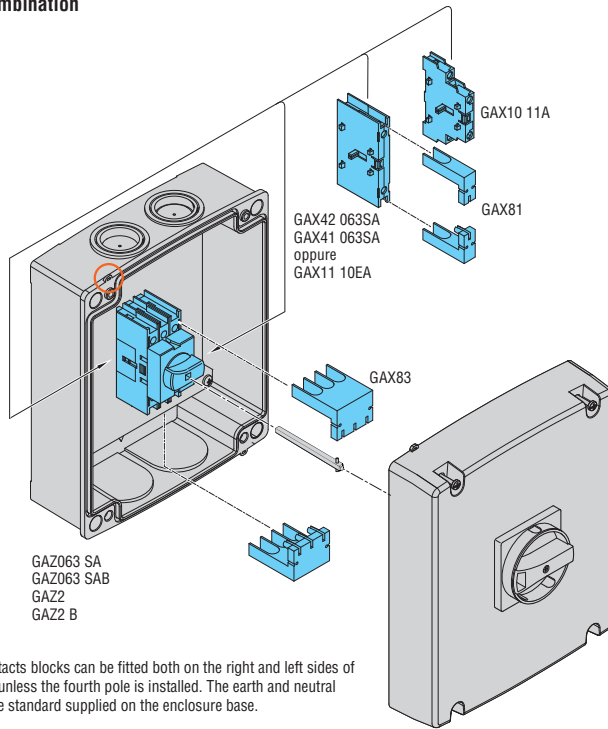

GAZ063 SA
GAZ063 SAB
GAZ2
GAZ2 B

Two auxiliary contacts blocks can be fitted both on the right and left sides of the disconnector unless the fourth pole is installed. The earth and neutral plate terminals are standard supplied on the enclosure base.

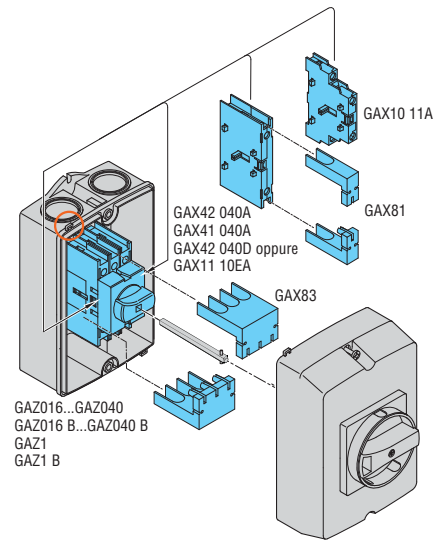

GAZ016...GAZ040
GAZ016 B...GAZ040 B
GAZ1
GAZ1 B

One auxiliary contact block can be fitted on the right and left sides of the disconnector unless the fourth pole is installed. The earth and neutral plate terminals are standard supplied on the enclosure base.

Sealing eyelet

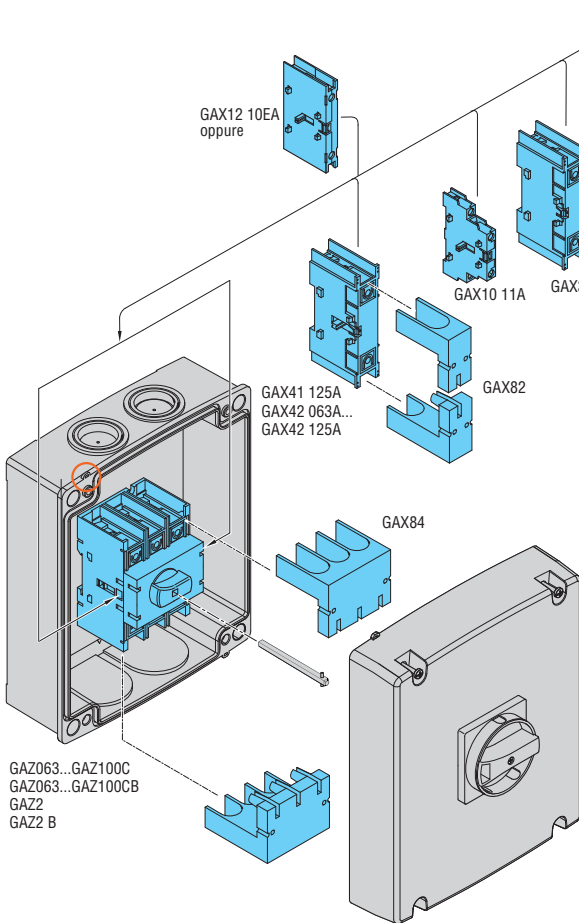
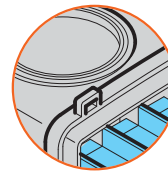

GAZ063...GAZ100C
GAZ063...GAZ100CB
GAZ2
GAZ2 B

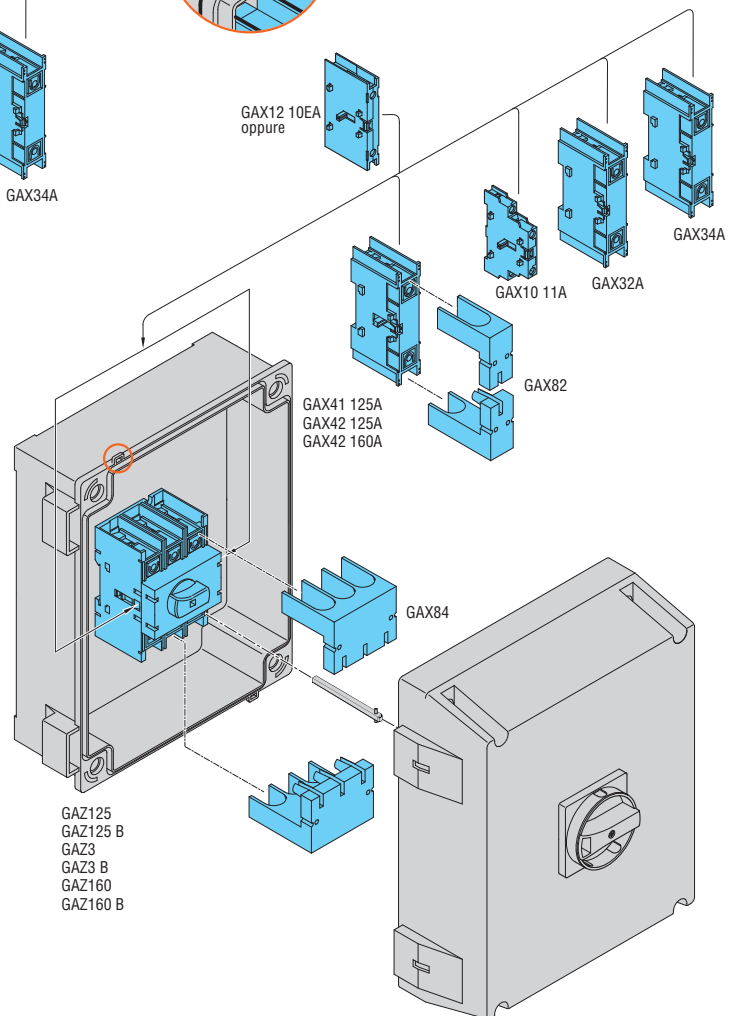

GAZ125
GAZ125 B
GAZ3
GAZ3 B
GAZ160
GAZ160 B

Two auxiliary contact blocks can be fitted both on the right and left sides of the disconnector unless the fourth pole is installed. Earth and neutral plate terminals are standard supplied on the box base. If any earth/ground and/or neutral terminals are required, type GAX3.... purchase separately.

Three pole switch disconnectors



GE...

Order code	IEC conventional free air thermal current Ith AC21A (≤500V)	IEC rated operational current Ie		Qty per pkg	Wt [kg]
		AC23A (≤400V)	AC23A (≤500V)		
	[A]	[A]	[A]	n°	[kg]
Separately purchase the handle and shaft extension ❶.					
GE0160 P ❶	160	160	125	1	0.850
GE0160	160	160	125	1	0.850
GE0200	200	160	125	1	0.900
GE0250	250 ❷	160	125	1	0.900
GE0251	250	250	200	1	1.700
GE0315	315	315	250	1	1.700
GE0400	400	400	315	1	1.900
GE0500	500	500	400	1	4.200
GE0630	630	630	500	1	4.200
GE0800	800	800	500	1	4.200
GE1000	1000	1000	800	1	7.000
GE1250	1250	1000	800	1	7.600
GE1600	1600	1000	900	1	20.800

Three-pole switch disconnectors with fuse holder



GE... F - GE...N - GE...B

With NFC fuse holder ❸❹.					
Separately purchase the handle and shaft extension ❶❷.					
Order code	Ith	Ie	Ie	Qty per pkg	Wt [kg]
GE0050 F ❶	50	50	50	1	1.250
GE0125 F ❶	125	125	125	1	1.700
With NH fuse holder ❸.					
Separately purchase the handle and shaft extension ❶❷.					
GE0160 N	160	160	125	1	1.700
GE0161 N	160	160	160	1	3.100
GE0250 N	250	250	250	1	6.600
GE0400 N	400	400	400	1	6.600
GE0630 N	630	630	630	1	13.000
GE0800 N	800	630	630	1	13.000
With BS fuse holder ❸.					
Separately purchase the handle and shaft extension ❶❷.					
GE0160 B	160	160	160	1	3.500
GE0200 B	200	200	200	1	3.500
GE0250 B	250	250	250	1	6.600
GE0315 B	315	315	315	1	6.600
GE0400 B	400	400	400	1	6.600
GE0630 B	630	630	630	1	13.000
GE0800 B	800	630	630	1	13.000

- ❶ Refer to the side table for the selection of the handle. A shaft insert is standard-supplied with all direct operating handles so no other shaft extension is required in this case.
- ❷ See table on page 11-22 for the types of fuses.
- ❸ The switch disconnector is standard-supplied with fuse protection shield.
- ❹ Standard supplied with IEC IP20 terminal protection.
- ❺ 250A Ith; 200A AC21A ≤500V.

Selection of handles
Refer to the left-hand switch disconnector table for the selection of the handle.
For other accessories see pages 11-19 and 11-20.

Direct operating	Door coupling	
Black	Black	Red/yellow
GEX65D	GAX66B	GAX66
GEX66ND	GEX66NB	GEX66N
GEX67ND	GEX67NB	GEX67N
GEX68ND	GEX68NB	GEX68N

Direct operating	Door coupling	
Black	Black	Red/yellow
GEX61D	GEX61NB	GEX61N
GEX62D	GEX66NB	GEX66N
GEX63D	GEX67NB	GEX67N
GEX64D	GEX68NB	GEX68N
Comando diretto	Door coupling	
Black	Black	Red/yellow
GEX62D	GEX66NB	GEX66N
GEX63D	GEX67NB	GEX67N
GEX64D	GEX68NB	GEX68N

- General characteristics**
- 50A to 1600A
 - Available versions: direct operating and door coupling
 - Screw fixing: 35mm DIN rail mount adapter kit for GE0160 P on p. 11-19
 - Padlockable in 0 position with no extra accessory.

- Operational characteristics**
- IEC rated insulation voltage Ui:
 - 1000V for GE0160...GE1600, GE0160 P, GE0250 N/B...GE0800 N/B
 - 800V for GE0050 F, GE0125 F, GE0160 N, GE0161 N, GE0160 B and GE0200 B
 - Mechanical life:
 - 30,000 cycles for GE0160...GE0250, GE0160 P
 - 20,000 cycles for GE0251...GE0400
 - 10,000 cycles for GE0500...GE1600, GE0050 F, GE0125 F, GE0160 N/B...GE0400 N/B
 - 5,000 cycles for GE0630 N/B and GE0800 N/B.

Certifications and compliance
Certifications obtained: EAC.
Compliant with standards: IEC/EN 60947-1, IEC/EN 60947-3.

Four-pole switch disconnectors



GE...T4...

Order code	IEC conventional free air thermal current Ith AC21A (≤500V)	IEC rated operational current Ie		Qty per pkg	Wt [kg]
	[A]	AC23A (≤400V)	AC23A (≤500V)		
		[A]	[A]	n°	[kg]
Separately purchase the handle and shaft extension ❶.					
GE0160 T4P ❶	160	160	125	1	1.000
GE0160 T4	160	160	125	1	1.000
GE0200 T4	200	160	125	1	1.000
GE0250 T4	250❷	160	125	1	1.000
GE0251 T4	250	250	200	1	1.900
GE0315 T4	315	315	250	1	1.900
GE0400 T4	400	400	315	1	2.100
GE0500 T4	500	500	400	1	4.500
GE0630 T4	630	630	500	1	4.500
GE0800 T4	800	800	500	1	4.500
GE1000 T4	1000	1000	800	1	7.600
GE1250 T4	1250	1000	800	1	7.600
GE1600 T4	1600	1000	900	1	20.800

Four-pole switch disconnectors with fuse holder



GE... FT4 - GE...NT4-GE...BT4

With NFC fuse holder ❸❹.					
Separately purchase the handle and shaft extension ❶❷.					
GE0050 FT4 ❹	50	50	50	1	1.550
GE0125 FT4 ❹	125	125	125	1	2.200
With NH fuse holder ❸.					
Separately purchase the handle and shaft extension ❶❷.					
GE0160 NT4	160	160	125	1	2.200
GE0161 NT4	160	160	160	1	8.000
GE0250 NT4	250	250	250	1	8.000
GE0400 NT4	400	400	400	1	8.000
GE0630 NT4	630	630	630	1	15.000
GE0800 NT4	800	630	630	1	15.000
With BS fuse holder ❸.					
Separately purchase the handle and shaft extension ❶❷.					
GE0160 BT4	160	160	160	1	4.000
GE0200 BT4	200	200	200	1	4.000
GE0250 BT4	250	250	250	1	4.000
GE0315 BT4	315	315	315	1	8.000
GE0400 BT4	400	400	400	1	8.000
GE0630 BT4	630	630	630	1	15.000
GE0800 BT4	800	630	630	1	15.000

- ❶ Refer to the side table for the selection of the handle. A shaft insert is standard-supplied with all direct operating handles so no other shaft extension is required in this case.
- ❷ See table on page 11-23 also for the types of fuses.
- ❸ The switch disconnector is standard-supplied with fuse protection shield.
- ❹ Standard supplied with IEC IP20 terminal protection.
- ❺ 250A Ith; 200A AC21A ≤500V.

Selection of handles

Refer to the left-hand switch disconnector table for the selection of the handle.
For the other accessories see pages 11-19 and 11-20.

Direct operating	Door coupling	
Black	Black	Red/yellow
GEX65D	GAX66B	GAX66
GEX66ND	GEX66NB	GEX66N
GEX67ND	GEX67NB	GEX67N
GEX68ND	GEX68NB	GEX68N

Direct operating	Door coupling	
Black	Black	Red/yellow
GEX61D	GEX61NB	GEX61N
GEX62D	GEX66NB	GEX66N
GEX63D	GEX67NB	GEX67N
GEX64D	GEX68NB	GEX68N
GEX62D	GEX66NB	GEX66N
GEX63D	GEX67NB	GEX67N
GEX64D	GEX68NB	GEX68N

General characteristics

- 50A to 1600A
- 4-pole types (3P+N) with early-make late-break neutral pole
- Available versions: direct operating and door coupling
- Screw fixing: 35mm DIN rail mount adapter kit for GE0160 T4P on p. 11-19
- Padlockable in 0 position with no extra accessory.

Operational characteristics

- IEC rated insulation voltage Ui:
 - 1000V for GE0160 T4...GE1600 T4, GE0160 T4P, GE0250...GE0800 NT4/BT4
 - 800V for GE0160 NT4/BT4, GE0050 FT4, GE0125 FT4, GE0161 NT4, GE0200 BT4
- Mechanical life:
 - 30,000 cycles for GE0160 T4...GE0250 T4, GE0160 T4P
 - 20,000 cycles for GE0251 T4...GE0400 T4
 - 10,000 cycles for GE0500 T4...GE1600 T4, GE0050 FT4, GE0125 FT4, GE0160...GE0400 NT4/BT4.
 - 5,000 cycles for GE0630 BT4/BT4 and GE0800 NT4/BT4.

Certifications and compliance

Certifications obtained: EAC.
Compliant with standards: IEC/EN 60947-1, IEC/EN 60947-3.

Three-pole changeover switches



GE...E

Order code	IEC conventional free air thermal current I _{th} AC21A (≤500V)	IEC rated operational current I _e		Qty per pkg	Wt [kg]
		AC23B (≤400V)	AC23B (≤500V)		
	[A]	[A]	[A]	n°	[kg]

Separately purchase the handle and shaft extension ❶.

GE0160 E	160	160	125	1	1.800
GE0200 E	200	160	125	1	1.900
GE0201 E	200	160	125	1	4.800
GE0250 E	250	180	150	1	4.800
GE0315 E	315	200	160	1	5.000
GE0400 E	400	250	200	1	5.000
GE0500 E	500	400	250	1	11.500
GE0630 E	630	500	315	1	11.500
GE0800 E	800	630	400	1	11.900
GE1000 E	1000	1000	800	1	21.800
GE1250 E	1250	1000	900	1	23.600
GE1600 E	1600	1000	900	1	50.000

Four-pole changeover switches



GE...ET4

Order code	IEC conventional free air thermal current I _{th} AC21A (≤500V)	IEC rated operational current I _e		Qty per pkg	Wt [kg]
		AC23B (≤400V)	AC23B (≤500V)		
	[A]	[A]	[A]	n°	[kg]

Separately purchase the handle and shaft extension ❶.

GE0160 ET4	160	160	125	1	2.100
GE0200 ET4	200	160	125	1	2.200
GE0201 ET4	200	160	125	1	5.300
GE0250 ET4	250	180	150	1	5.300
GE0315 ET4	315	200	160	1	5.500
GE0400 ET4	400	250	200	1	5.500
GE0500 ET4	500	400	250	1	12.600
GE0630 ET4	630	500	315	1	12.600
GE0800 ET4	800	630	400	1	13.200
GE1000 ET4	1000	1000	800	1	24.300
GE1250 ET4	1250	1000	900	1	26.700
GE1600 ET4	1600	1000	900	1	55.000

❶ Refer to the side table for the selection of the handle. A shaft insert is standard-supplied with all direct operating handles so no other shaft extension is required in this case.

Selection of handles

Refer to the left-hand changeover switch table for the selection of the handle.
For the other accessories see pages 11-19 and 11-20.

Direct operating	Door coupling
Black	Black
GEX61E	GEX61NC
GEX62NE	GEX62NC
GEX63NE	GEX63NC
GEX64NE	GEX64NC

Selection of handles

Refer to the left-hand changeover switch table for the selection of the handle.
For the other accessories see pages 11-19 and 11-20.

Direct operating	Door coupling
Black	Black
GEX61E	GEX61NC
GEX62NE	GEX62NC
GEX63NE	GEX63NC
GEX64NE	GEX64NC

General characteristics

- 160A to 1600A
- 4-pole types (3P+N) with early-make late-break neutral pole
- Available versions: direct operating and door coupling
- Screw fixing
- Padlockable in 0 position with no extra accessory.

Operational characteristics

- IEC rated insulation voltage U_i: 1000V
- Mechanical life: 30,000 cycles for GE0160 E/ET4 and GE0200 E/ET4 only; 10,000 cycles for other types.

Certifications and compliance

Certifications obtained: EAC.
Compliant with standards: IEC/EN 60947-1, IEC/EN 60947-3.



GEX10...



GEX89 00



GEX8...



GEX691C



GEX69...

Order code	Description	Qty per pkg	Wt
		n°	[kg]

Auxiliary contacts ①②.

GEX10 11①②	1NA/1NC changeover	1	0.032
-------------------	--------------------	---	-------

Auxiliary contacts for switch disconnector types GE0050 F, GE0050 FT4, GE0125 F, GE0125 FT4, GE0160 N and GE0160 NT4.

GEX10 11N②	1NA/1NC changeover	1	0.024
-------------------	--------------------	---	-------

Auxiliary contacts for switch disconnector types GE0160 E, GE0200 E, GE0160 ET4, GE0200 ET4, GE1600 E and GE1600 ET4.

GEX10 11M②	1NA/1NC changeover	1	0.016
-------------------	--------------------	---	-------

Adapter kit for 35mm DIN fixing.

GEX89 00	For GE...P types only	1	0.040
-----------------	-----------------------	---	-------

Set of terminal covers consisting of pieces given below. See pages from 11-21 to 11-23 and 11-25 for choice according to switch disconnector type. Screw fixing.

GEX81 01	1-piece set, transparent sheet covering 4 poles	1	0.048
GEX81 11	2-piece set, each covers two poles	1	0.080
GEX81 21	2-piece set, each covers two poles	1	0.140
GEX81 31	2-piece set, each covers two poles	1	0.170
GEX81 41	2-piece set, each covers two poles	1	0.440

Snap-on fixing.

GEX82 01	3-piece set, each covers one pole	1	0.090
GEX82 03	4-piece set, each covers one pole	1	0.120
GEX82 11	3-piece set, each covers one pole	1	0.120
GEX82 12	3-piece set, each covers one pole	1	0.120
GEX82 13	4-piece set, each covers one pole	1	0.160
GEX82 21	3-piece set, each covers one pole	1	0.240
GEX82 22	3-piece set, each covers one pole	1	0.240
GEX82 23	4-piece set, each covers one pole	1	0.320
GEX82 31	3-piece set, each covers one pole	1	0.340
GEX82 32	3-piece set, each covers one pole	1	0.340
GEX82 33	4-piece set, each covers one pole	1	0.440
GEX83 11	3-piece set, each covers one pole	1	0.120
GEX83 12	4-piece set, each covers one pole	1	0.160
GEX83 21	3-piece set, each covers one pole	1	0.260
GEX83 22	4-piece set, each covers one pole	1	0.340
GEX83 31	3-piece set, each covers one pole	1	0.360
GEX83 32	4-piece set, each covers one pole	1	0.460

Motorised control unit for changeover switches. Rated auxiliary supply voltage 230VAC/DC. Complete with control handle, shaft extension and fixing elements.



GEX69 0C	For GE0160 E...GE0200 E and GE0160 ET4...GE0200 ET4	1	3.000
GEX69 1C	For GE0201 E...GE0400 E and GE0201 ET4...GE0400 ET4	1	3.000
GEX69 2	For GE0500 E...GE0800 E and GE0500 ET4...GE0800 ET4	1	5.340
GEX69 3	For GE1000 E...GE1600 E and GE1000 ET4...GE1600 ET4	1	5.753

① Unsuitable for switch disconnectors type GE0050 F, GE0050 FT4, GE0125 F, GE0125 FT4, GE0160 N, GE0160 NT4, GE0160 E, GE0200 E, GE0160 ET4, GE0200 ET4, GE1600 E and GE1600 ET4.

② Changeover contact.

Selection of add-on contacts and accessories

Refer to the combinations given on pages 11-21 to 23 and 11-25 for a correct choice based on the switch disconnector type used.

General characteristics for auxiliary contacts

IEC conventional free air thermal current I_{th}: 16A.

General characteristics for motorised control unit

- IEC rated auxiliary supply voltage: 230VAC/DC
- 4 static outputs, 24VDC 120mA total
- 4 inputs, contacts powered at 24VDC or 5VDC (500mA) for changeover control (pulsed or continuous)
- RS485 Modbus (only for GEX692, GEX693) serial port for control, monitoring, programming
- Padlockable at 0 position
- Programming by position inputs
- 4-digit display for status-error indications.

Certifications and compliance

Certifications obtained: EAC.
Compliant with standards: IEC/EN 60947-1, IEC/EN 60947-3.



GEX...D-GEX...E



GEX6 2NE



GAX66



GEX6 6N



GEX6 8N



GEX6 7NB



GAX7...A



GEX7...

For the correct choice of handles and shaft extensions with switch disconnector see tables on pages 11-20 to 23 and 11-25.

Order code	Characteristics	Qty per pkg	Wt
		n°	[kg]

DIRECT OPERATING LEVER HANDLE, PADLOCKABLE ❶.
Rotating type with screw fixing on switch disconnector.
Complete with shaft extension.

GEX6 1D	95mm/3.7" black lever	1	0.340
GEX6 1E	50mm/2" black lever	1	0.052
GEX6 2D	105mm/4.1" black lever	1	0.268
GEX6 2NE	143mm/5.6" black lever	1	0.266
GEX6 3D Ⓣ	245mm/9.6" black lever	1	0.536
GEX6 3NE	176mm/6.9" black lever	1	0.424
GEX6 4D Ⓣ	360mm/14.2" black lever	1	0.612
GEX6 4NE Ⓣ	396mm/15.6" black lever	1	0.612
GEX6 5D	50mm/2" black lever	1	0.054
GEX6 6ND	115mm/4.5" black lever	1	0.216
GEX6 7ND	143mm/5.6" black lever	1	0.322
GEX6 8ND Ⓣ	396mm/15.6" black lever	1	0.328

DOOR COUPLING LEVER HANDLE, PADLOCKABLE ❶.
Red/yellow rotating type with screw fixing on door.
Shaft extension to order separately ❶.
Defeatable (requirement UL508A).

GAX66 Ⓣ	65mm/2.6" lever. □ 7mm/0.3" Ⓣ. IP66	1	0.075
GEX6 1N	94mm/3.7" lever. □ 7mm/0.3". IP65	1	0.326
GEX6 6N	115mm/4.5" lever. □ 10mm/0.4". IP65	1	0.248
GEX6 7N	143mm/5.6" lever. □ 14mm/0.6". IP65	1	0.302
GEX6 8N Ⓣ	396mm/15.6" lever. □ 14mm/0.6". IP65	1	0.312

DOOR COUPLING LEVER HANDLE, PADLOCKABLE ❶.
Black rotating type with screw fixing on door.
Shaft extension to order separately ❶.
Defeatable (requirement UL508A).

GAX66 B Ⓣ	65mm/2.6". □ 7mm/0.3" Ⓣ. IP66	1	0.075
GEX6 1NB	94mm/3.7". □ 7mm/0.3". IP65	1	0.334
GEX6 1NC	94mm/3.7". □ 7mm/0.3". IP65	1	0.074
GEX6 2NC	143mm/5.6". □ 10mm/0.4". IP65	1	0.252
GEX6 3NC	176mm/6.9". □ 14mm/0.6". IP65	1	0.302
GEX6 4NC Ⓣ	396mm/15.6". □ 14mm/0.6". IP65	1	0.488
GEX6 6NB	115mm/4.5". □ 10mm/0.4". IP65	1	0.246
GEX6 7NB	143mm/5.6". □ 14mm/0.6". IP65	1	0.298
GEX6 8NB Ⓣ	396mm/15.6". □ 14mm/0.6". IP65	1	0.310

SHAFT EXTENSIONS for door coupling handles ❶.

GAX7 150A	150mm/5.9", □ 7mm/0.3"	1	0.090
GAX7 200A	200mm/7.9", □ 7mm/0.3"	1	0.112
GAX7 300A	300mm/11.8", □ 7mm/0.3"	1	0.160
GEX7 162N	177mm/7", □ 7mm/0.3"	1	0.056
GEX7 195N	195mm/7.7", □ 14mm/0.6"	1	0.248
GEX7 227N	227mm/8.9", □ 10mm/0.4"	1	0.154
GEX7 239N	239mm/9.4", □ 14mm/0.6"	1	0.310
GEX7 250N	250mm/9.8", □ 7mm/0.3"	1	0.084
GEX7 345N	345mm/13.6", □ 14mm/0.6"	1	0.480
GEX7 375N	375mm/14.7", □ 10mm/0.4"	1	0.274
GEX7 387N	387mm/15.2", □ 7mm/0.3"	1	0.142
GEX7 536N	536mm/21.1", □ 10mm/0.4"	1	0.408
GEX7 535N	535mm/21", □ 14mm/0.6"	1	0.784
GEX7 485N	485mm/19.1", □ 14mm/0.6"	1	0.930

❶ See tables on pages 11-19 to 21 and 11-23 for the correct choice based on the switch disconnector type used.

Ⓣ 2-hand control.

Ⓣ Use with GAX7...A extension types only.

Certifications and compliance

Certification obtained: EAC for all; cULus according to UL98A/CSA C22.2 no. 4 only for types GAX66... and GAX7...A.

Compliant with standards: IEC/EN 60947-1, IEC/EN 60947-3.

Form and handle length	Handle types
50mm/2"	GEX61E-GEX65D
65mm/2.6"	GAX66-GAX66B
94mm/3.7"	GEX61N-GEX61NB GEX61NC
95mm/3.74"	GEX61D
105mm/4.1"	GEX62D
115mm/4.5"	GEX66ND-GEX66NB GEX66N
143mm/5.6"	GEX62NC-GEX62NE GEX67N-GEX67NB GEX67ND
176mm/6.9"	GEX63NC-GEX63NE
245mm/9.6"	2-hand GEX63D
360mm/14.2"	2-hand GEX64D
396mm/15.6"	2-hand GEX64NC-GEX64NE GEX68N-GEX68NB GEX68ND

Summary table of combinations - Three and four-pole changeover switches

Type	IEC conventional thermal current I _{th}		IEC rated free air current		Direct operating handle			Door coupling handles			Extensions for door coupling handles (the last 3 digits of GEX code indicate length in mm/in)		Auxiliary contacts 1NO/1NC	Motorised control unit	Terminal covers for:		
	AC21A (≤500V)	AC23B (≤400V)	AC23B (≤500V)	Black	Black	Red/yellow	Order code	Order code	Order code	Order code	□	[mm/in]	Order code	Order code	Line 1	Line 2	Load

Changeover switches. Three poles.

GE0160 E	160	160	125	GEX61E	GEX61NC	—	GEX7162N	7mm/ 0.3"	269/10.59" 342/13.36" 479/18.86"	GEX1011M	GEX690C	GEX8101	Ⓢ	Ⓢ			GEX8101			
GE0200 E	200	160	125															GEX7250N	GEX7387N	
GE0201 E	200	160	125	GEX62NE	GEX62NC	—	GEX7227N	10mm/ 0.4"	279/10.98" 427/16.81" 588/23.15"	GEX1011	GEX691C	GEX8212	GEX8211	GEX8311						
GE0250 E	250	180	150															GEX7375N	GEX7536N	
GE0315 E	315	200	160															GEX7195N	GEX7345N	GEX7535N
GE0400 E	400	250	200															GEX7195N	GEX7345N	GEX7535N
GE0500 E	500	400	250	GEX63NE	GEX63NC	—	GEX7195N	14mm/ 0.6"	257/10.12" 407/16.02" 597/23.50"	GEX1011M	GEX692	GEX8222	GEX8221	GEX8321						
GE0630 E	630	500	315															GEX7345N	GEX7535N	
GE0800 E	800	630	400	GEX64NE	GEX64NC	—	GEX7195N	14mm/ 0.6"	280/11.02" 430/16.93" 620/24.41"	GEX1011M	GEX693	GEX8232	GEX8231	GEX8331						
GE1000 E	1000	1000	800															GEX7239N	GEX7485N	
GE1250 E	1250	1000	900															GEX7239N	GEX7485N	
GE1600 E	1600	1000	900			—	GEX7239N	14mm/ 0.6"	579/22.79" 825/32.48"	GEX1011M		GEX8141	—	GEX8141						

Changeover switches. Four poles.

GE0160 ET4	160	160	125	GEX61E	GEX61NC	—	GEX7162N	7mm/ 0.3"	269/10.59" 342/13.36" 479/18.86"	GEX1011M	GEX690C	GEX8101	Ⓢ	Ⓢ			GEX8101			
GE0200 ET4	200	160	125															GEX7250N	GEX7387N	
GE0201 ET4	200	160	125	GEX62NE	GEX62NC	—	GEX7227N	10mm/ 0.4"	279/10.86" 427/16.81" 588/23.15"	GEX1011	GEX691C	GEX8213	GEX8213	GEX8312						
GE0250 ET4	250	180	150															GEX7375N	GEX7536N	
GE0315 ET4	315	200	160															GEX7195N	GEX7345N	GEX7535N
GE0400 ET4	400	250	200															GEX7195N	GEX7345N	GEX7535N
GE0500 ET4	500	400	250	GEX63NE	GEX63NC	—	GEX7195N	14mm/ 0.6"	257/10.12" 407/16.02" 597/23.50"	GEX1011M	GEX692	GEX8223	GEX8223	GEX8322						
GE0630 ET4	630	500	315															GEX7345N	GEX7535N	
GE0800 ET4	800	630	400	GEX64NE	GEX64NC	—	GEX7195N	14mm/ 0.6"	280/11.02" 430/16.93" 620/24.41"	GEX1011M	GEX693	GEX8233	GEX8233	GEX8332						
GE1000 ET4	1000	1000	800															GEX7239N	GEX7485N	
GE1250 ET4	1250	1000	900															GEX7239N	GEX7485N	
GE1600 ET4	1600	1000	900			—	GEX7239N	14mm/ 0.6"	579/22.79" 825/32.48"	GEX1011M		GEX8141	—	GEX8141						

Ⓢ GEX81 01 terminal cover protects the input of both Line 1 and Line 2; nothing else is required for Line 2.

Summary table of combinations - Three-pole switch disconnectors

Three pole type ①	IEC conventional free air thermal current I _{th}		IEC rated operational current I _e		Direct operating handle			Door coupling handles			Extensions for door coupling handles (the last 3 digits of GEX code indicate length in mm/in)		Auxiliary contacts 1NO/1NC	Type of fuse	Terminal covers for:	
	AC21A (≤500V)	AC23A (≤400V)	AC23A (≤500V)	Black	Black	Red/yellow	Exten. section	Max panel depth	Line	Load						
Order code	[A]	[A]	[A]	Order code	Order code	Order code	Order code	<input type="checkbox"/>	[mm/in]	Order code		Order code	Order code			

Switch disconnectors.

GE0160 P ②	160	160	125	GEX65D	GAX66B	GAX66	GAX7150A ⑤ GAX7200A ⑤ GAX7300A ⑤	7mm/ 0.3"	214/8.42" 264/10.39" 364/14.33"	GEX1011	—	②	②
GE0160	160	160	125										
GE0200	200	160	125										
GE0250 ③	250 ③	160	125										
GE0251	250	250	200	GEX66ND	GEX66NB	GEX66N	GEX7227N GEX7375N GEX7536N	10mm/ 0.4"	267/10.51" 415/16.34" 576/22.68"	GEX1011	—	②	②
GE0315	315	315	250										
GE0400	400	400	315										
GE0500	500	500	400										
GE0630	630	630	500	GEX67ND	GEX67NB	GEX67N	GEX7195N GEX7345N GEX7535N	14mm/ 0.6"	251/9.88" 401/15.79" 591/23.27"	GEX1011	—	②	②
GE0800	800	800	500										
GE1000	1000	1000	800										
GE1250	1250	1000	800										
GE1600	1600	1000	900	GEX68ND	GEX68NB	GEX68N	GEX7239N GEX7485N	14mm/ 0.6"	399/15.71" 645/25.39"	GEX1011	—	②	②

Switch disconnectors with NFC fuse holder.

GE0050 F ④	50	50	50	GEX61D	GEX61NB	GEX61N	GEX7162N GEX7250N GEX7387N	7mm/ 0.3"	192/7.56" 265/10.43" 402/15.83"	GEX1011N	14x51 22x58	④	④
GE0125 F ④	125	125	125										

Switch disconnectors with NH fuse holder.

GE0160 N	160	160	125	GEX61D	GEX61NB	GEX61N	GEX7162N GEX7250N GEX7387N	7mm/ 0.3"	192/7.56" 265/10.43" 402/15.83"	GEX1011N	00	GEX8201	GEX8201
GE0161 N	160	160	160										
GE0250 N	250	250	250	GEX62D	GEX66NB	GEX66N	GEX7227N GEX7375N GEX7536N	10mm/ 0.4"	302/11.89" 450/11.72" 611/24.05"	GEX1011	0	GEX8211	GEX8212
GE0400 N	400	400	400										
GE0630 N	630	630	630										
GE0800 N	800	630	630	GEX63D	GEX67NB	GEX67N	GEX7195N GEX7345N GEX7535N	14mm/ 0.6"	271/10.67" 421/16.57" 611/24.05"	GEX1011	1 2	GEX8221	GEX8222
GE0630 N	630	630	630										
GE0800 N	800	630	630	GEX64D	GEX68NB	GEX68N	GEX7195N GEX7345N GEX7535N	14mm/ 0.6"	285/11.22" 435/17.12" 625/24.61"	GEX1011	3	GEX8231	GEX8232
GE0800 N	800	630	630										

Switch disconnectors with BS fuse holder.

GE0160 B	160	160	160	GEX62D	GEX66NB	GEX66N	GEX7227N GEX7375N GEX7536N	10mm/ 0.4"	302/11.89" 450/11.72" 611/24.05"	GEX1011	A4 B1-B2	GEX8211	GEX8212
GE0200 B	200	200	200										
GE0250 B	250	250	250										
GE0315 B	315	315	315	GEX63D	GEX67NB	GEX67N	GEX7195N GEX7345N GEX7535N	14mm/ 0.6"	271/10.67" 421/16.57" 611/24.05"	GEX1011	B1-B2-B3 B1-B2-B3-B4	GEX8221	GEX8222
GE0400 B	400	400	400										
GE0630 B	630	630	630	GEX64D	GEX68NB	GEX68N	GEX7195N GEX7345N GEX7535N	14mm/ 0.6"	285/11.22" 435/17.12" 625/24.61"	GEX1011	C1-C2 C1-C2-C3	GEX8231	GEX8232
GE0800 B	800	630	630										

① The motorised control unit cannot be installed.

② Standard supplied with IP20 terminal protection warranted by wired equipment with only maximum conductor section of 95mm². Suitable for mounting on 35mm DIN rail, GEX89 00 kit is available on page 11-19.

③ 250A I_{th}; 200A AC21A ≤500V.

④ Standard supplied with IEC IP20 terminal protection warranted by wired equipment with only maximum conductor section of 35mm² for GE0050 F and of 95mm² for GE0125 F.

⑤ Extension length for type GAX7150A is 186mm/7.32", type GAX7200A 236mm/9.29" and type GAX7300A 336mm/13.23".

Summary table of combinations - Four-pole switch disconnectors

Four pole type ①	IEC conventional free air thermal current I _{th}	IEC rated operational current I _e		Direct operating handle	Door coupling handles		Extensions for door coupling handles (the last 3 digits of GEX code indicate length in mm/in)		Auxiliary contacts 1NO/1NC	Type of fuse	Terminal covers for:	
		AC21A (≤500V)	AC23A (≤400V)	AC23A (≤500V)				Exten. section			Max panel depth	Line
Order code	[A]	[A]	[A]	Order code	Order code	Order code	Order code	<input type="checkbox"/>	[mm/in]	Order code	Order code	Order code

Switch disconnectors.

GE0160 T4P ②	160	160	125	GEX65D	GAX66B	GAX66	GAX7150A ③ GAX7200A ③ GAX7300A ③	7mm/ 0.3"	214/8.42" 264/10.39" 364/14.33"	GEX1011	—	④	④
GE0160 T4	160	160	125										
GE0200 T4	200	160	125										
GE0250 T4 ⑤	250⑤	160	125										
GE0251 T4	250	250	200	GEX66ND	GEX66NB	GEX66N	GEX7227N GEX7375N GEX7536N	10mm/ 0.4"	267/10.51" 415/16.34" 576/22.68"	GEX1011	—	④	④
GE0315 T4	315	315	250										
GE0400 T4	400	400	315										
GE0500 T4	500	500	400										
GE0630 T4	630	630	500	GEX67ND	GEX67NB	GEX67N	GEX7195N GEX7345N GEX7535N	14mm/ 0.6"	251/9.88" 401/15.79" 591/23.27"	GEX1011	—	④	④
GE0800 T4	800	800	500										
GE1000 T4	1000	1000	800										
GE1250 T4	1250	1000	800										
GE1600 T4	1600	1000	900	GEX68ND	GEX68NB	GEX68N	GEX7239N GEX7485N	14mm/ 0.6"	399/15.71" 645/25.39"	GEX1011	—	④	④

Switch disconnectors with NFC fuse holder.

GE0050 FT4 ⑥	50	50	50	GEX61D	GEX61NB	GEX61N	GEX7162N GEX7250N GEX7387N	7mm/ 0.3"	192/7.56" 265/10.43" 402/15.83"	GEX1011N	14x51 22x58	④	④
GE0125 FT4 ⑥	125	125	125										

Switch disconnectors with NH fuse holder.

GE0160 NT4	160	160	125	GEX61D	GEX61NB	GEX61N	GEX7162N GEX7250N GEX7387N	7mm/ 0.3"	192/7.56" 265/10.43" 402/15.83"	GEX1011N	00	GEX8203	GEX8203							
GE0161 NT4	160	160	160					GEX62D	GEX66NB		GEX66N			GEX7227N GEX7375N GEX7536N	10mm/ 0.4"	302/11.89" 450/17.72" 611/24.05"	GEX1011	0	GEX8213	GEX8213
GE0250 NT4	250	250	250												GEX63D	GEX67NB		GEX67N		
GE0400 NT4	400	400	400	GEX64D	GEX68NB	GEX68N	GEX7195N GEX7345N GEX7535N	14mm/ 0.6"	285/11.22" 435/17.12" 625/24.61"	3	GEX8233	GEX8233								
GE0630 NT4	630	630	630																	
GE0800 NT4	800	630	630																	

Switch disconnectors with BS fuse holder.

GE0160 BT4	160	160	160	GEX62D	GEX66NB	GEX66N	GEX7227N GEX7375N GEX7536N	10mm/ 0.4"	302/11.89" 450/17.72" 611/24.05"	GEX1011	A4 B1-B2	GEX8213	GEX8213						
GE0200 BT4	200	200	200					GEX63D	GEX67NB		GEX67N			GEX7195N GEX7345N GEX7535N	14mm/ 0.6"	271/10.67" 421/16.57" 611/24.05"	B1-B2-B3 B1-B2-B3-B4	GEX8223	GEX8223
GE0250 BT4	250	250	250												GEX64D	GEX68NB	GEX68N		
GE0315 BT4	315	315	315																
GE0400 BT4	400	400	400																
GE0630 BT4	630	630	630	GEX64D	GEX68NB	GEX68N	GEX7195N GEX7345N GEX7535N	14mm/ 0.6"	285/11.22" 435/17.12" 625/24.61"	C1-C2 C1-C2-C3	GEX8233	GEX8233							
GE0800 BT4	800	630	630																

① The motorised control unit cannot be installed.

② Standard supplied with IP20 terminal protection warranted by wired equipment with only maximum conductor section of 95mm². Suitable for mounting on 35mm DIN rail, GEX89 00 kit is available on page 11-19.

③ 250A I_{th}; 200A AC21A ≤500V.

④ Standard supplied with IEC IP20 terminal protection warranted by wired equipment with only maximum conductor section of 35mm² for GE0050 FT4 and of 95mm² for GE0125 FT4.

⑤ Extension length for type GAX7150A is 186mm/7.32", type GAX7200A 236mm/9.29" and type GAX7300A 336mm/13.23".

GA series switch disconnectors



GA040 D



GAX42...D

Order code	IEC conventional free air thermal current Ith	IEC rated operational current Ie DC21B ^{①②}			Qty per pkg	Wt [kg]
		3 poles 500V	4 poles 600V	800V		
[A]	[A]	[A]	[A]	[A]	n°	[kg]

Switch disconnector complete with black handle.

GA040 D	40	12	—	—	1	0.135
----------------	----	----	---	---	---	-------

Fourth pole.

GAX42 040D	40	—	20	15	1	0.040
-------------------	----	---	----	----	---	-------

- ① Connection of 4 poles in series.
- ② For other operational voltages, refer to technical characteristics on page 11-37.

GD series switch disconnectors



GD040 AT4



Order code	IEC conventional free air thermal current Ith	IEC rated operational current Ie DC21B ^②			Qty per pkg	Wt [kg]
		800V	1000V	1200V		
[A]	[A]	[A]	[A]	[A]	n°	[kg]

Switch disconnector complete with black handle.

GD025 AT2	25	25	16	—	1	0.100
------------------	----	----	----	---	---	-------

GD032 AT3	32	32	32	—	1	0.110
------------------	----	----	----	---	---	-------

GD040 AT4	40	40	40	32	1	0.120
------------------	----	----	----	----	---	-------

- ② For other operational voltages, refer to technical characteristics on page 11-37.

General characteristics

- Up to 40A, 1000VDC and 32A, 1200VDC
- Modular construction
- Jumpers for connecting the poles in series supplied as standard with disconnectors GD series...
- Available versions:
 - Direct operating
 - Door coupling version. Use switch disconnector with direct actuator and separately purchase the handle and shaft extension for this version. See pages 11-8 to 11-10
- Screw or 35mm DIN rail fixing
- Padlockable in 0 position with no extra accessory.

Operational characteristics

- Rated insulation voltage for GA...D and GD...
 - Ui: 1000V (pollution degree 3)
- Rated insulation voltage for GD...
 - Ui: 1500V (pollution degree 2)
- Rated impulse withstand Uimp: 8kV
- Mechanical life:
 - 100,000 cycles GA040 D
 - 10,000 cycles GD...
- Operating temperature: -25°C...+55°C
- Storage temperature: -40°C...+70°C
- Degree of protection: IP20.

Certifications and compliance

Certifications obtained: EAC; UL Listed for USA and Canada (cULus - File E93602) as Manual Motor Controllers, to UL508/CSA C22.2 n° 14 for GA040 D and GAX42 040D.
Compliant with standards: IEC/EN 60947-3, IEC/EN 60947-1, UL508.

Strokes of GA...D types (main poles and add-on pole)

	Travel 0→1	0°	30°	60°	90°
GA040 D Main poles				60°	
GAX420 40D Simultaneous fourth-pole add on				60°	

IEC/EN IP65 enclosed GD series switch disconnectors



GAZ016 DT2



GAZ040 DT4

Order code	IEC conventional free air thermal current Ith	IEC rated operational current Ie DC21B ^②			Qty per pkg	Wt [kg]
		800V	1000V	1200V		
[A]	[A]	[A]	[A]	[A]	n°	[kg]

With red/yellow handle.

GAZ025 DT2	25	25	16	—	1	0.450
-------------------	----	----	----	---	---	-------

GAZ032 DT3	32	32	32	—	1	1.050
-------------------	----	----	----	---	---	-------

GAZ040 DT4	40	40	40	32	1	1.050
-------------------	----	----	----	----	---	-------

With black handle.

GAZ025 DT2B	25	25	16	—	1	0.450
--------------------	----	----	----	---	---	-------

GAZ032 DT3B	32	32	32	—	1	1.050
--------------------	----	----	----	---	---	-------

GAZ040 DT4B	40	40	40	32	1	1.050
--------------------	----	----	----	----	---	-------

- ② For other operational voltages, refer to technical characteristics on page 11-37.

Components

Enclosure	Switch disconnector	Handle
GAZ1	GD025 AT2	GAX61
GAZ2 ^③	GD032 AT3	GAX61
GAZ2 ^③	GD040 AT4	GAX61
GAZ1B	GD025 AT2	GAX61B
GAZ2B ^③	GD032 AT3	GAX61B
GAZ2B ^③	GD040 AT4	GAX61B

- ③ For further details contact our Customer Service office; see contact details on inside front cover.

General characteristics

- Enclosure material: ABS
- Possible accessories to mount afterwards, if any required:
 - GAX30 to provide shielded cable connection continuity (e.g. with static converters)
- Padlockable handles
- Sealable cover
- Tightening torque for cover screws:
 - GAZ025...: 1.3Nm/16lbin
 - Other types: 1.5Nm/13lbin.
- Degree of protection: IP65
- Cable entry:
 - GAZ025... types: PG16/M25 and PG13.5/M20 knockouts
 - GAZ032... and GAZ040... types: PG16/M25 and PG29/M32 knockouts.

Certifications and compliance

Certifications obtained: EAC
Compliant with standards: IEC/EN 60947-3, IEC/EN 60947-1.

Four-pole switch disconnectors



GE...DT4

Order code	IEC conventional free air thermal current I _{th}	IEC rated operational current I _e DC21B ②③			Qty per pkg	Wt [kg]
		220V	800V	1000V		
	[A]	[A]	[A]	[A]	n°	[kg]

Direct operating and door coupling versions.
Separately purchase the handle and shaft extension ①.

GE0125 DT4	125	125	125	100	1	1.900
GE0250 DT4	250	250	250	200	1	2.000
GE0315 DT4	315	315	280	250	1	4.000
GE0630 DT4	630	630	600	500	1	4.500
GE0800 DT4	800	800	630	630	1	4.500
GE1250 DT4	1250	1250	1000	850	1	8.900

- ① Refer to the side table for the selection of the handle. A shaft insert is standard-supplied with all direct operating handles so no other shaft extension is required in this case.
- ② Connection of 4 poles in series.
- ③ For other operational voltages, refer to technical characteristics on page 11-38.

Selection of handles and accessories

Refer to the left-hand switch disconnector table for the selection of the handle.
For the other accessories see pages 11-19 and 11-20.

Direct operating Black	Door coupling	
	Black	Red/yellow
GEX66ND	GEX66NB	GEX66N
GEX67ND	GEX67NB	GEX67N
GEX68ND	GEX68NB	GEX68N

General characteristics

- Up to 850A, 1000VAC
- Available versions:
 - Direct operating
 - Door coupling. Use switch disconnector with direct actuator and separately purchase the handle and shaft extension for this version. See page 11-20
- Screw fixing
- Padlockable in 0 position with no extra accessory.

Operational characteristics

- IEC rated insulation voltage U_i: 1000V
- Mechanical life:
 - 20,000 cycles for GE0125 DT4, GE0250 DT4, GE0315 DT4
 - 10,000 cycles for GE0630 DT4, GE0800 DT4, GE1250 DT4.

Certifications and compliance

Certifications obtained: EAC.
Compliant with standards: IEC/EN 60947-1, IEC/EN 60947-3.

Summary table of combinations - switch disconnectors for photovoltaic applications

Four pole type ⑤	IEC conventional free air thermal current I _{th}	IEC rated operational current I _e DC21B ②			Direct operating handle	Door coupling handles			Extensions for door coupling handles (the last 3 digits of GEX code indicate length in mm/in)		Auxiliary contacts 1NO/1NC	Terminal covers for:	
		600V	800V	1000V	Black	Black	Red/yellow	Exten. section	Max panel depth	Line	Load		
Order code	[A]	[A]	[A]	[A]	Order code	Order code	Order code	Order code	<input type="checkbox"/>	[mm/in]	Order code	Order code	Order code
Switch disconnectors for photovoltaic applications.													
GE0125 DT4	125	125	125	100	GEX66ND	GEX66NB	GEX66N	GEX7227N	10mm/0.4"	267/10.51"	GEX1011	GEX8111	GEX8111
GE0250 DT4	250	250	250	200				GEX7375N		415/16.34"			
GE0315 DT4	315	315	280	250				GEX7536N		576/22.68"			
GE0630 DT4	630	630	600	500	GEX67ND	GEX67NB	GEX67N	GEX7195N	14mm/0.6"	251/19.88"		GEX8121	GEX8121
GE0800 DT4	800	700	630	630				GEX7345N		401/15.79"			
GE1250 DT4	1250	1250	1000	850	GEX68ND	GEX68NB	GEX68N	GEX7535N		591/23.27"		GEX8131	GEX8131
										267/10.51"			
										417/16.42"			
										607/23.90"			

⑤ The motorised control unit cannot be installed.

GA SERIES - 16A TO 160A SWITCH DISCONNECTORS

Direct operating version

GA016 A...GA040 A
GA063 SA
GA040 D

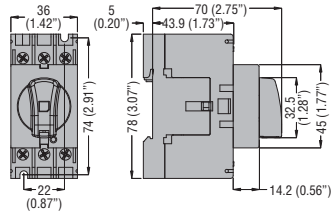

GA063 A...GA160 A

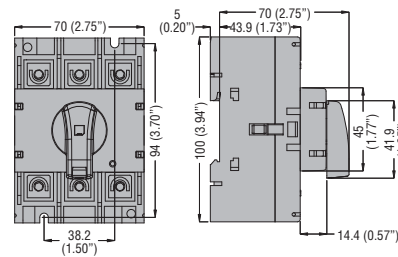

Door mount version
GA016 C...GA040 C

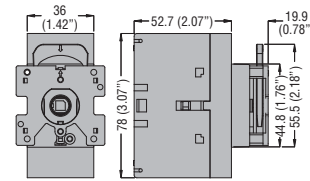

GA063 C...GA125 C

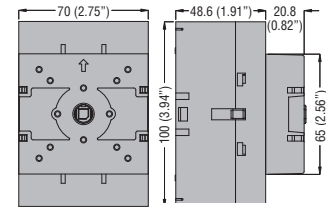

ADD-ON BLOCKS AND ACCESSORIES

For GA016 A...GA040 A, GA063 SA, GA040 D

Auxiliary contacts

GAX10 11A
GAX11 10EA

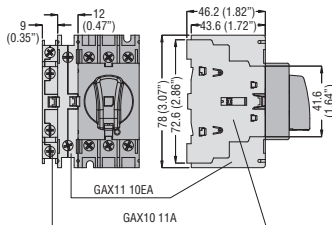

Fourth pole

GAX41 040A - GAX42 040A
GAX41 063SA - GAX42 063SA
GAX42 040D

Neutral **GAX31 A** - earth/ground **GAX33 A** terminals

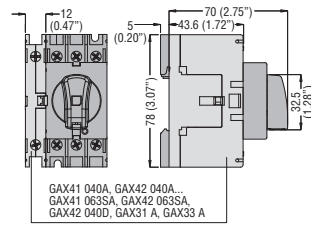

Mechanical interlock **GAX50 00** and mechanical coupling system **GAX60 00**

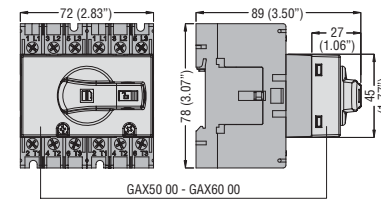

For GA063 A...GA160 A

Auxiliary contacts

GAX10 11A
GAX12 10EA

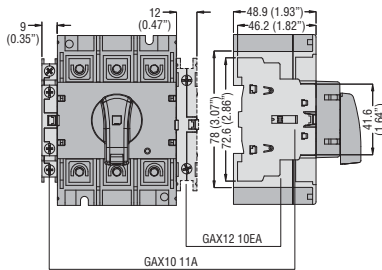

Fourth pole

GAX41 125A
GAX42 063A...GAX42 160A

Neutral **GAX32 A** - earth/ground **GAX34 A** terminals

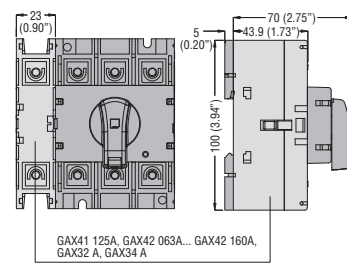

Mechanical interlock **GAX50 01** and mechanical coupling system **GAX60 01**

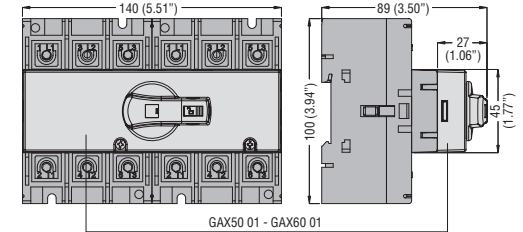

For GA016 C...GA040 C

Auxiliary contacts **GAX10 11C**

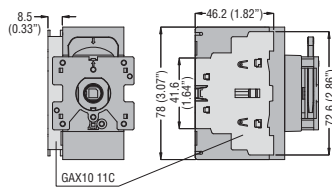

Fourth pole **GAX41 040C - GAX42 040C**

Neutral **GAX31 C** - earth/ground **GAX33 C** terminals

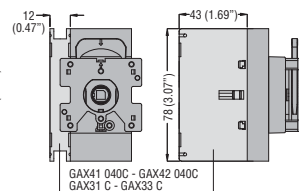

For GA063 C...GA125 C

Auxiliary contacts **GAX10 11C**

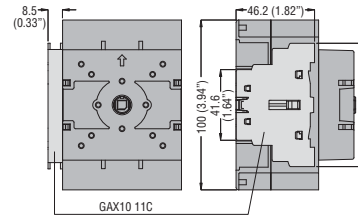

Fourth pole **GAX41 125C - GAX42 063C...GAX42 125C**

Neutral **GAX32 C** - earth/ground **GAX34 C** terminals

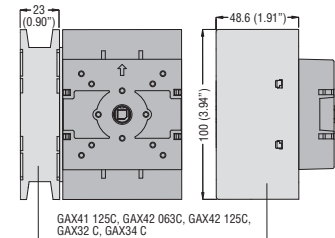

GD SERIES SWITCH DISCONNECTORS

Direct operating version

GD025 AT2

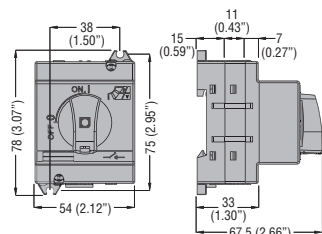

GD032 AT3

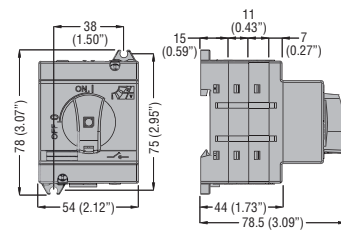

GD040 AT4

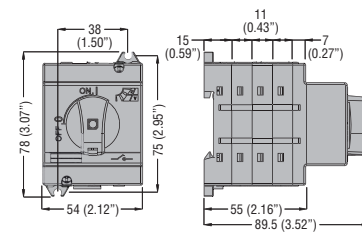

Handles

GAX61/61B

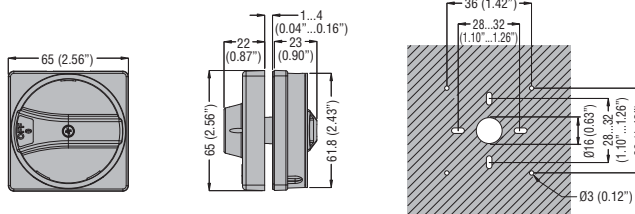

GAX62/62B

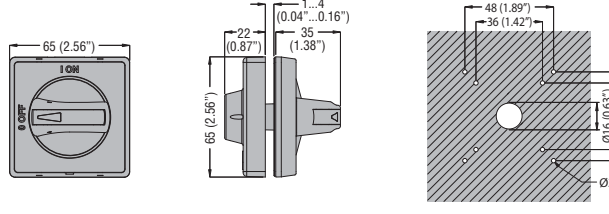

GAX63/63B

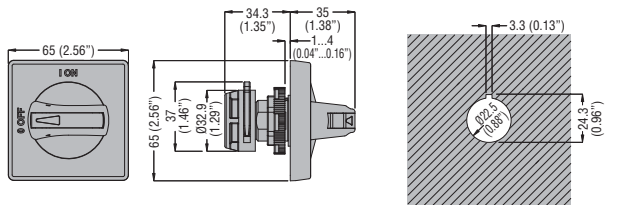

GAX63 1B

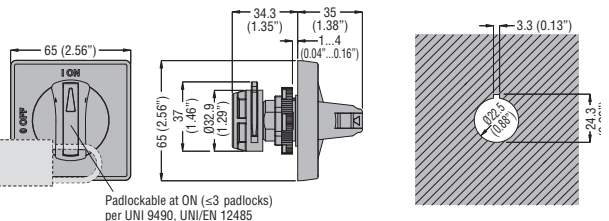

GAX63 2/2B

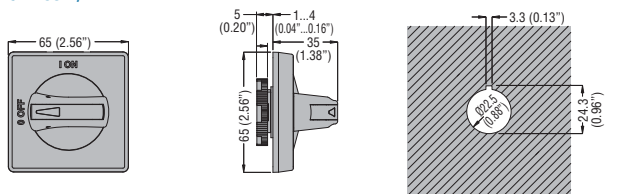

GAX64/64B

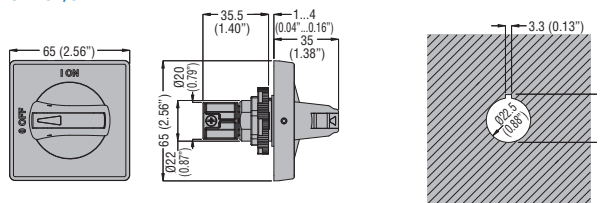

GAX66/66B

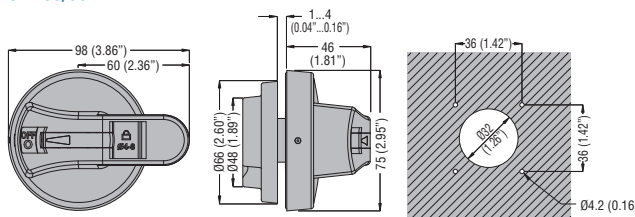

GAX67 B

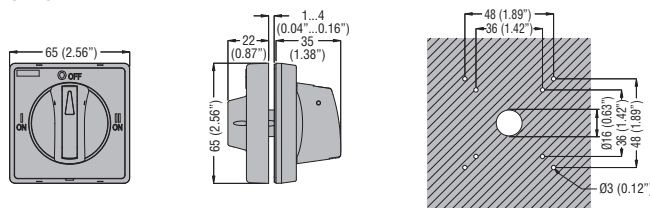

GAX68/68B

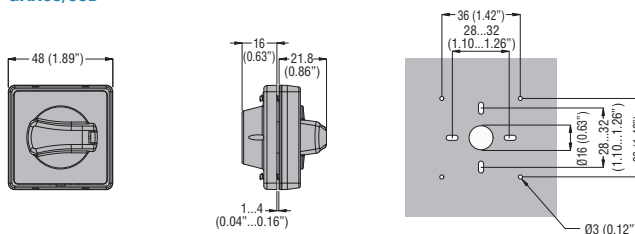

Shaft extensions for door coupling handles

GAX7...

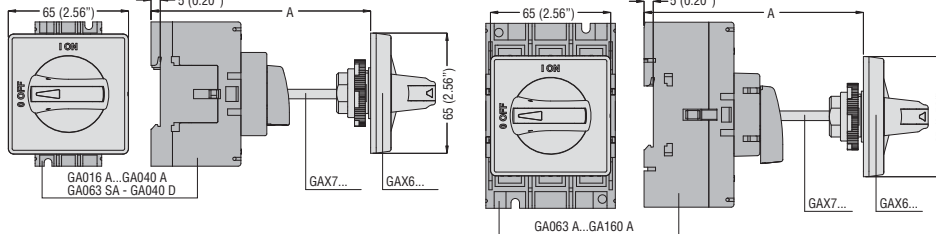

Extension	Length [mm (in)]	A [mm (in)] maximum					
		Type of handle					
		GAX61...	GAX62...	GAX63...	GAX64...	GAX67 B	GAX68...
GAX7055	55 (2.16")	99 (3.90")	97 (3.82")	102 (4.01")	116 (4.57")	97 (3.82")	98.5 (3.88")
GAX7070	70 (2.75")	114 (4.49")	112 (4.41")	117 (4.61")	131 (5.16")	112 (4.41")	113.5 (4.47")
GAX7090	90 (3.54")	134 (5.27")	132 (5.20")	137 (5.39")	151 (5.94")	132 (5.20")	133.5 (5.25")
GAX7150	150 (5.90")	194 (7.64")	192 (7.56")	197 (7.75")	211 (8.31")	192 (7.56")	193.5 (7.62")
GAX7200	200 (7.87")	244 (9.61")	242 (9.53")	247 (9.72")	261 (10.27")	242 (9.53")	243.5 (9.59")
GAX7300	300 (11.81")	344 (13.54")	342 (13.46")	347 (13.66")	361 (14.21")	342 (13.46")	343.5 (13.52")
GAX7400	400 (15.75")	444 (17.48")	442 (17.40")	447 (17.60")	461 (18.15")	442 (17.40")	443.5 (17.46")
GAX7500	500 (19.68")	544 (21.42")	542 (21.34")	547 (21.53")	561 (22.09")	542 (21.34")	543.5 (21.40")

GAX7... used with GAX50 00, GAX50 01 and GAX60 00

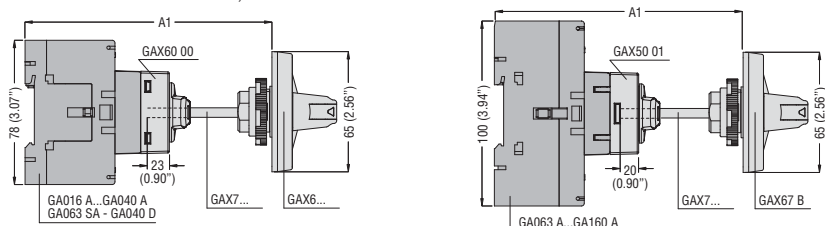

Extension	Length [mm (in)]	A1 [mm (in)] maximum					
		Used with GAX60 00		Used with GAX50 00/GAX50 01			
		GAX61...	GAX62...	GAX63...	GAX64...	GAX68...	GAX67 B
GAX7055	55 (2.16")	116 (4.57")	114 (4.49")	119 (4.68")	133 (5.24")	115.5 (4.55")	114 (4.49")
GAX7070	70 (2.75")	131 (5.16")	129 (5.08")	134 (5.27")	148 (5.83")	130.5 (5.14")	129 (5.08")
GAX7090	90 (3.54")	151 (5.94")	149 (5.87")	154 (6.06")	168 (6.61")	150.5 (5.92")	149 (5.87")
GAX7150	150 (5.90")	211 (8.31")	209 (8.23")	214 (8.42")	228 (8.98")	210.5 (8.29")	209 (8.23")
GAX7200	200 (7.87")	261 (10.27")	259 (10.20")	264 (10.39")	278 (10.94")	260.5 (10.25")	259 (10.20")
GAX7300	300 (11.81")	361 (14.21")	359 (14.13")	364 (14.33")	378 (14.88")	360.5 (14.20")	359 (14.13")
GAX7400	400 (15.75")	461 (18.15")	459 (18.07")	464 (18.27")	468 (18.42")	460.5 (18.13")	459 (18.07")
GAX7500	500 (19.68")	561 (22.09")	559 (22.01")	564 (22.20")	578 (22.75")	560.5 (22.07")	559 (22.01")

GAX7...A used with GAX60 B and GAX66/66B

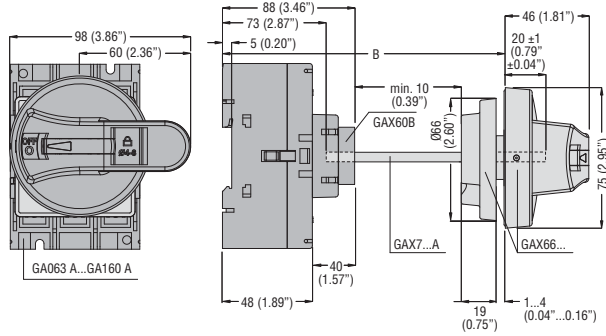

GAX7...A used with GAX60 01 and GAX66/66B

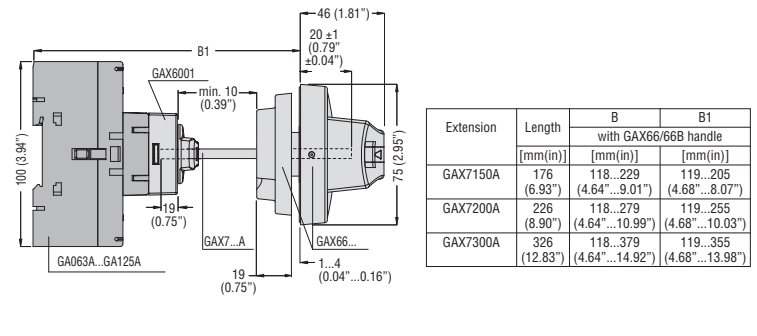

Terminal covers

GAX81 - GAX83

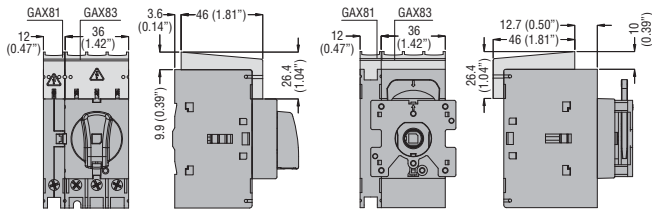

GAX82 - GAX84

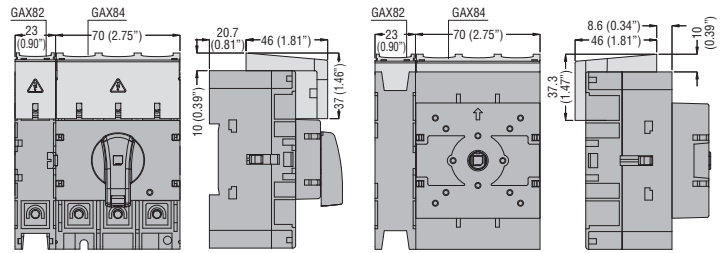

Fuse holder

GAX39 1 - GAX39 1UL

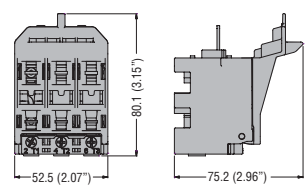

ENCLOSED SWITCH DISCONNECTORS AND EMPTY ENCLOSURES

- GAZ016...GAZ040...
- GAZ016...GAZ040...UL
- GAZ1... - GAZ1...UL
- GAZ025D...

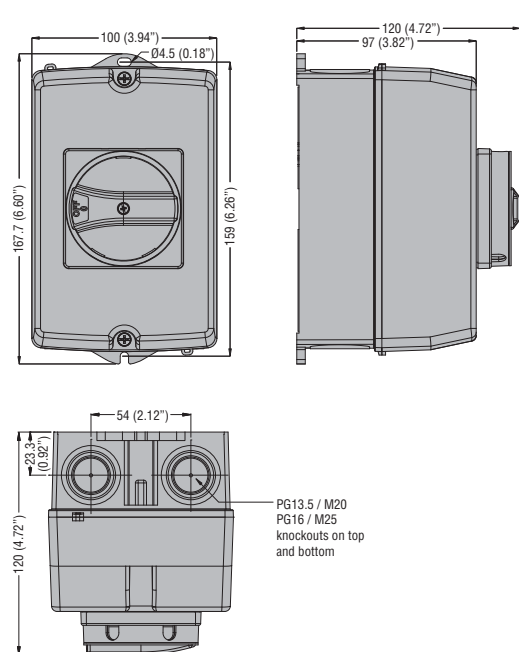

- GAZ063 SA...GAZ100 C...
- GAZ063 SAUL...
- GAZ2... - GAZ2...UL

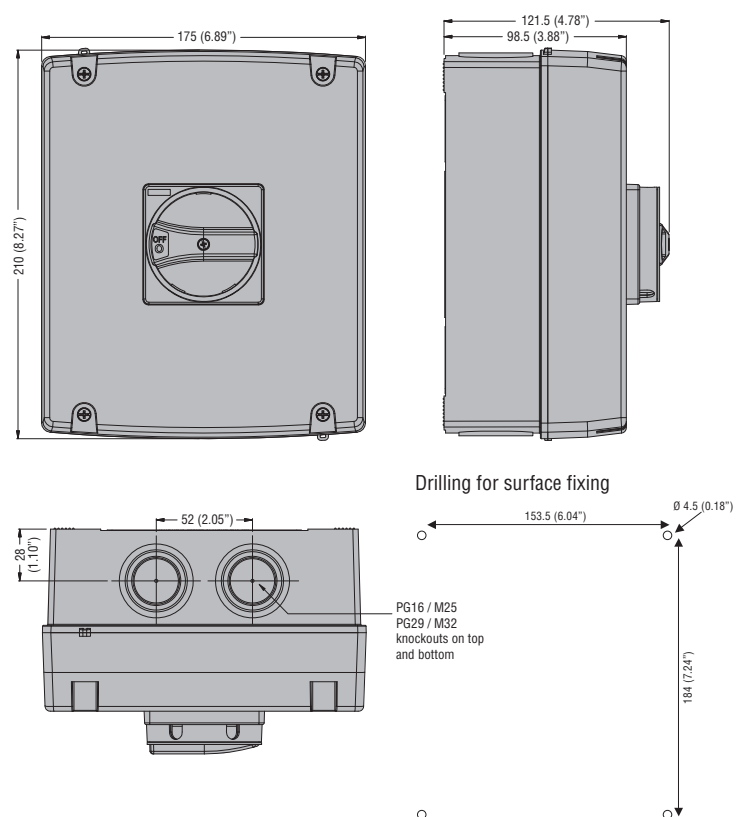

Switch disconnectors

Dimensions [mm (in)]

GAZ025 ET6...GAZ063 SAET6 - GAZ025 ET8...GAZ063 SAET8- GAZ032 D... - GAZ040 D...

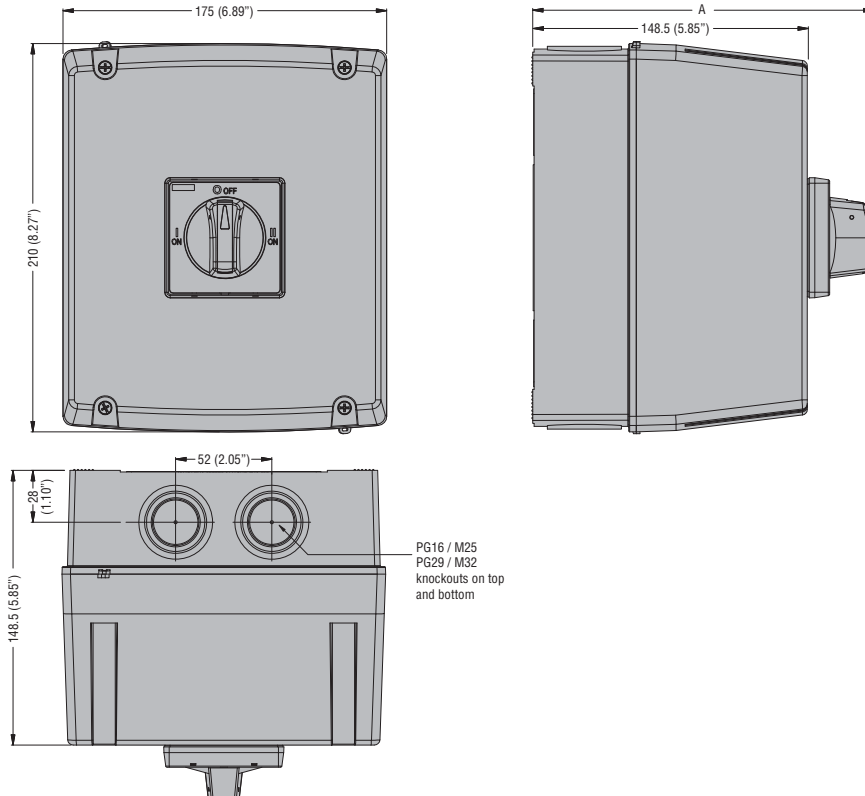

Drilling

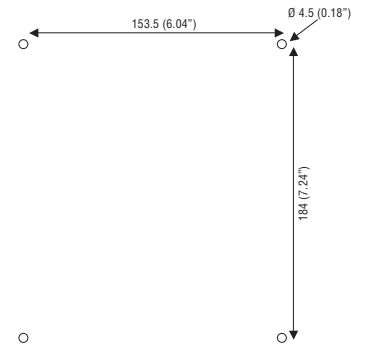

Type	A
GAZ032 D...	171.5 (6.75")
GAZ040 D...	171.5 (6.75")
GAZ025 ET...	183.5 (7.22")
GAZ063 SAET...	183.5 (7.22")

GAZ125... - GAZ063...UL - GAZ125...UL - GAZ3... - GAZ080 ET6 - GAZ125 ET6 - GAZ160 ET6 - GAZ080 ET8 - GAZ125 ET8 - GAZ160 ET8

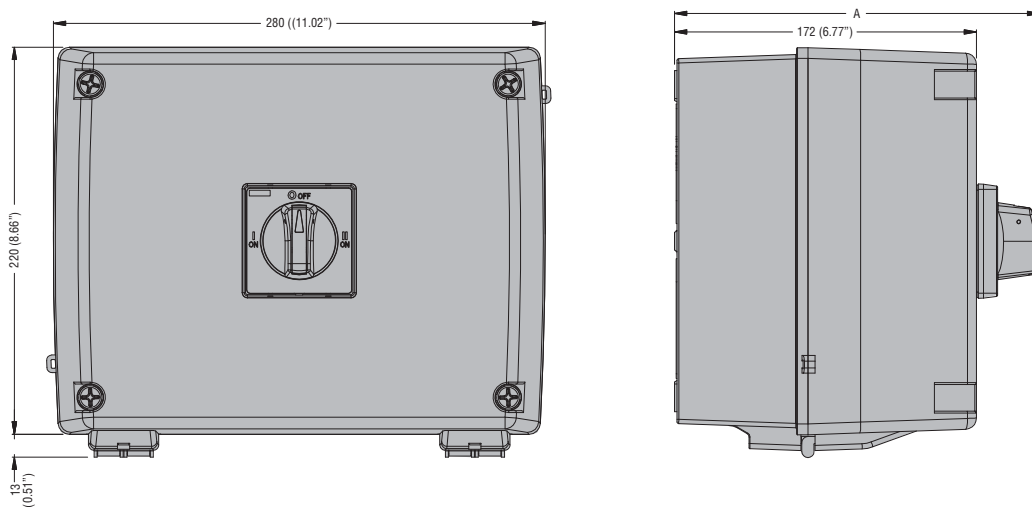

Type	A
GAZ125	193 (7.60")
GAZ063...UL	193 (7.60")
GAZ125...UL	193 (7.60")
GAZ3...	193 (7.60")
GAZ080 ET6	208 (8.19")
GAZ125 ET6	208 (8.19")
GAZ160 ET6	208 (8.19")
GAZ080 ET8	208 (8.19")
GAZ125 ET8	208 (8.19")
GAZ160 ET8	208 (8.19")

GAZ125... - GAZ160... - GAZ080 UL...GAZ125...UL - GAZ3...

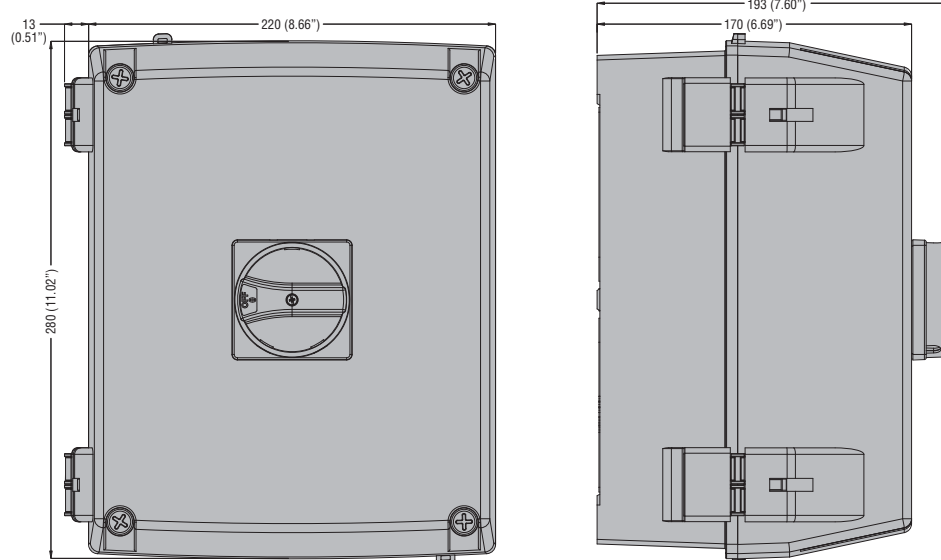

OPEN AND ENCLOSED GA SERIES 16A TO 160A SWITCH DISCONNECTORS

Three-pole disconnectors
GA016...GA160A/C
GAZ016...GAZ160/B
GAZ016UL...GAZ125UL

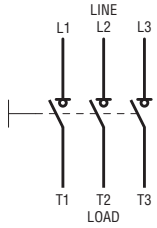

Fourth pole
GAX42...

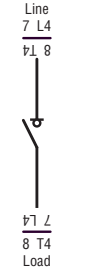

GAX41...



Four-pole disconnectors
GAZ016 T4...GAZ160 T4
GAZ016 T4UL...GAZ125 T4UL

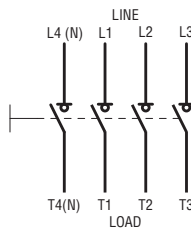

ADD-ON BLOCKS AND ACCESSORIES

Auxiliary contacts
GAX10...

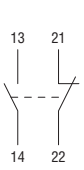

GAX11... - GAX12...



Neutral terminal
GAX31... - GAX32...



Earth/Ground terminal
GAX33... - GAX34...



Fuse holder
GAX39 1

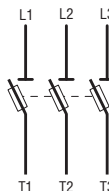

ENCLOSED CHANGEOVER SWITCHES

Three-pole **GAZ...ET6**

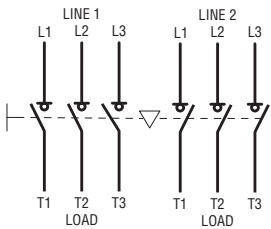

Four-pole **GAZ...ET8**

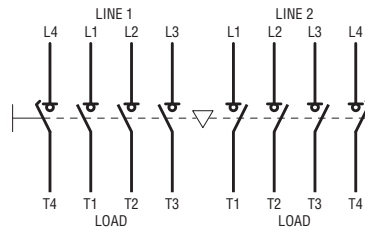

GE SERIES - 50A TO 1600A SWITCH DISCONNECTORS

Three-pole disconnectors
GE0160 - GE1600
GE0160 P

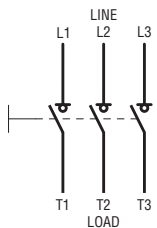

Three-pole disconnectors with fuse holders
GE0050 F - GE0125 F
GE0160 N - GE0800 N
GE0160 B - GE0800 B

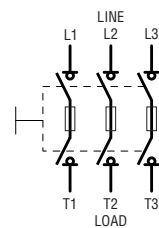

Four-pole disconnectors
GE0160 T4 - GE1600 T4
GE0160 T4P

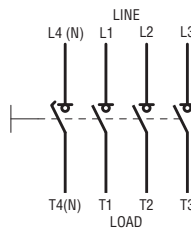

Four-pole disconnectors with fuse holders
GE0050 FT4 - GE0125 FT4
GE0160 NT4 - GE0800 NT4
GE0160 BT4 - GE0800 BT4

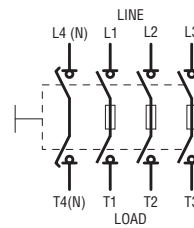

160A TO 1250A CHANGEOVER SWITCHES

Three-pole switches
GE0160 E - GE0200 E

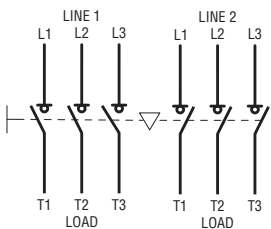

GE0201 E - GE1600 E

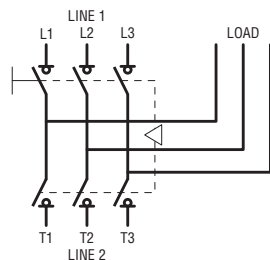

Four-pole switches
GE0160 ET4 - GE0200 ET4

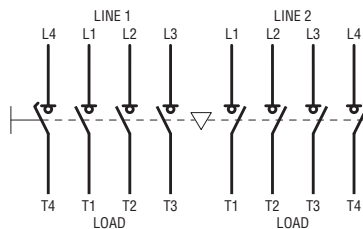

GE0201 ET4 - GE1600 ET4

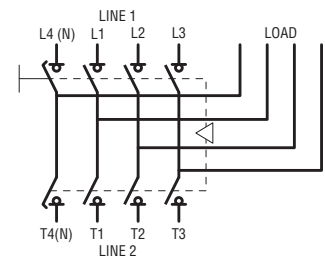

ADD-ON BLOCKS AND ACCESSORIES

Auxiliary contacts
GEX10 11 - GEX10 11M - GEX10 11N



Motorised control unit
GEX69 0C - GEX69 1C

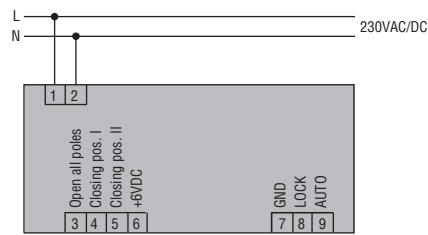

Motorised control unit
GEX69 2 - GEX69 3

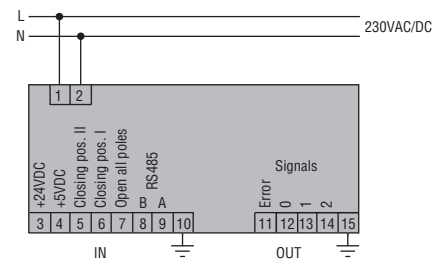

SWITCH DISCONNECTORS FOR PHOTOVOLTAIC APPLICATIONS **GA...D** (poles in series to wire)

One-line control
 2 poles in series

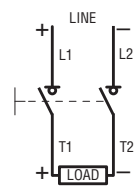

3 poles in series

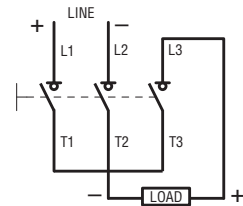

4 poles in series

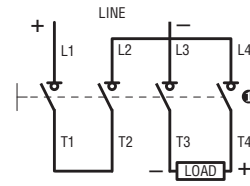

Two-lines control
 2+2 poles in series

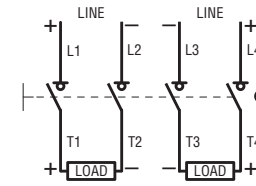

① The positive pole fitted on the right side of the disconnector can also be fitted on the left side; the connections must be changed in consequence.

SWITCH DISCONNECTORS FOR PHOTOVOLTAIC APPLICATIONS **GD...** (jumpers supplied as standard)

One-line control
GD025 AT2

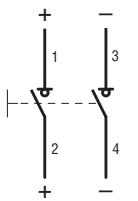

GD032 AT3

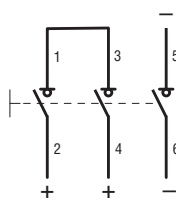

GD040 AT4

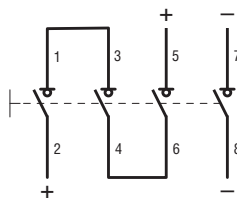

SWITCH DISCONNECTORS FOR PHOTOVOLTAIC APPLICATIONS **GE...DT4** (poles in series to wire)

One-line control
 4 poles in series

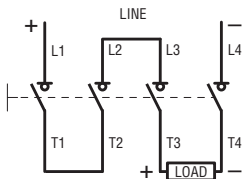

4 (2+2) poles in series

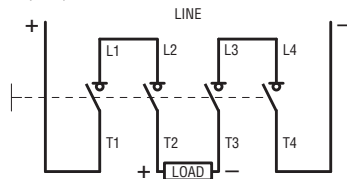

Switch disconnectors

Technical characteristics

GA series 16A to 160A

TYPE	Three pole	GA016...	GA025...	GA032...	GA040...	GA063 SA	GA063...	GA080...	GA100...	GA125...	GA160A	
	4th pole	GAX42 040...	GAX42 040...	GAX42 040...	GAX42 040...	GAX42 063SA	GAX42 063...	GAX42 080...	GAX42 100...	GAX42 125...	GAX42 160A	
CONTACT CHARACTERISTICS												
IEC conventional free air thermal current I _{th} (≤40°C)	A	16	25	32	40	63	63	80	100	125	160	
IEC rated insulation voltage U _i	V	1000										
IEC rated impulse withstand voltage U _{imp}	kV	8										
IEC rated operational current I _e												
AC21A	400V	A	16	25	32	40	63	63	80	100	125	160
	500V	A	16	25	32	40	63	63	80	100	125	160
	690V	A	16	25	32	40	63	63	80	100	125	160
AC22A	400V	A	16	25	32	40	45	63	80	100	125	125
	500V	A	16	25	32	40	45	63	80	100	125	125
	690V	A	16	25	32	40	45	63	80	100	125	125
AC23A	400V	A	16	25	32	40	45	63	80	100	125	125
	500V	A	16	25	25	25	25	63	63	80	100	100
	690V	A	16	25	25	25	25	47	47	47	47	47
Power dissipation	W/pole	0.2	0.4	0.6	1.0	2.9	1.6	2.6	4.0	6.3	12	
IEC rated operational power												
AC23A	400V	kW	7.5	11	15	18.5	22	30	45	55	55	55
	690V	kW	11	22	22	22	22	45	45	45	45	45
IEC reactive power for control of capacitors 400V	kvar	7.5	10	12.5	15	15	25	30	40	50	50	
Short circuit protection												
Rated short-time current (1s) I _{cs}	A rms	800					2500					
Conditional short-circuit current	kA rms	50										
With fuse class gG	A	16	25	32	40	63	63	80	100	125	160	
Making capacity AC23A 400V	A	400				450		1250				
Breaking capacity AC23A 400V	A	320				360		1000				
Mechanical life	cycles	100,000				100,000		30,000				
Electrical life (AC21A)	cycles	100,000				15,000		30,000			1,500	
Terminals	type	Pillar terminal										
	A mm	5.6					12.4					
	B mm	6.5					10.4					
	Screw	M4					M8					
	Tool	Phillips 2					Metric Allen key 4					
Tightening torque	Nm	1.8...2					5...6					
	lbin	16...18					45...54					
Conductor section min...max	mm ²	0.75...16					4...70					
	AWG	18...6					12...1					
AMBIENT CONDITIONS												
Temperature	Operating	°C	-25...+55									
	Storage	°C	-40...+70									
Maximum altitude	m	3000										
Mounting position	Normal	Vertical										
	Admissible	Any										
Fixing	By screw or on 35mm DIN rail (IEC/EN 60715)											



MOUNTING POSITION

The performances, given in this catalogue, have been established with GE series switch disconnectors mounted on a vertical place with line terminals facing upwards and load terminals facing downwards.

All GE series switch disconnectors can be mounted as illustrated in the following figures without any derating except for position A. It is not recommended to mount switch disconnectors with the neutral pole facing downwards.

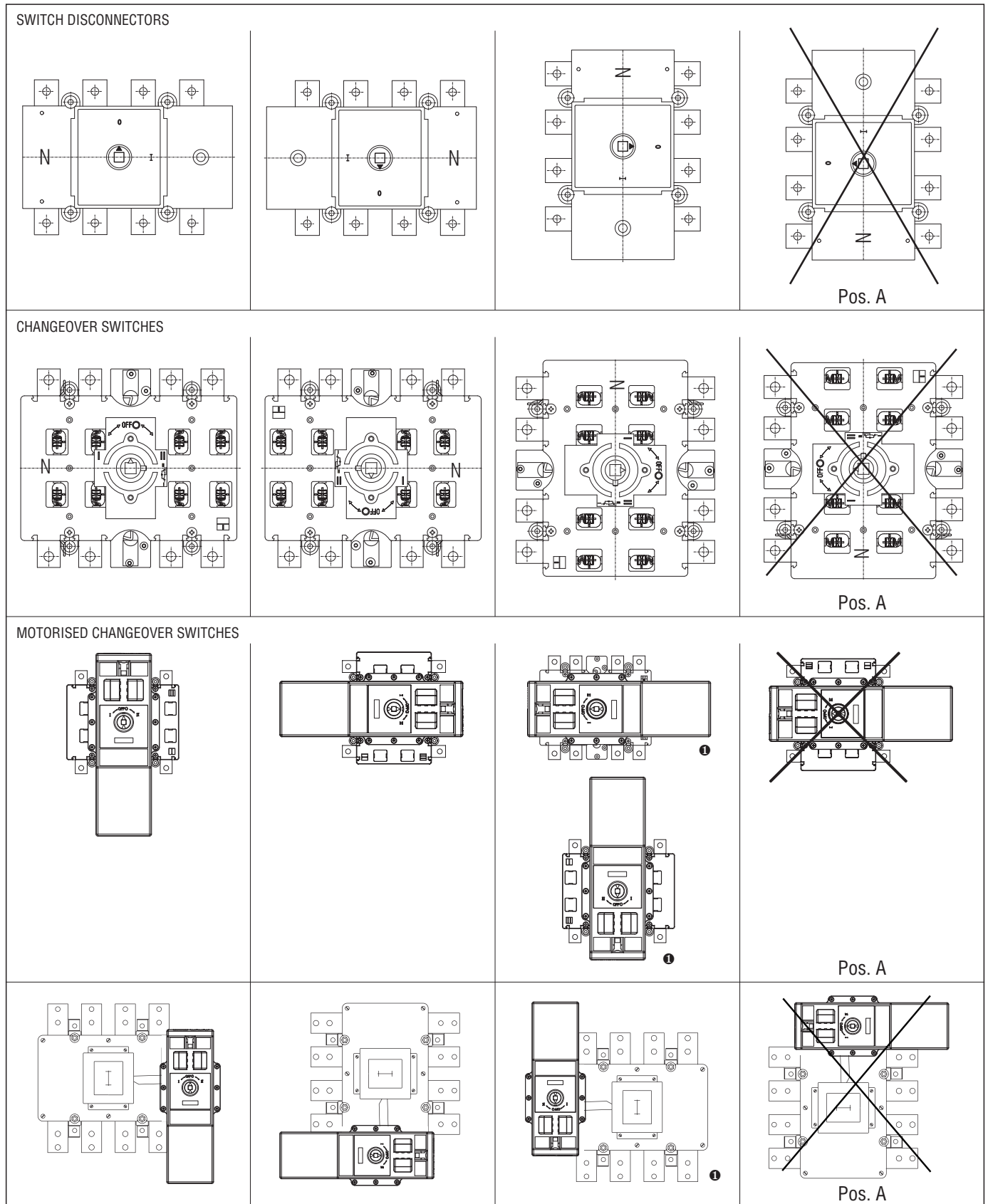

I Special assembly. Contact our Customer Service office (Tel. +39 035 4282422; E-mail: service@LovatoElectric.com) for details.

Switch disconnectors

Technical characteristics

GE series 160A to 1600A - Three and four-pole

TYPE		3-pole	GE0160P GE0160	GE0200	GE0250	GE0251	GE0315	GE0400	GE0500	GE0630	GE0800	GE1000	GE1250	GE1600
		4-pole ⑤	GE0160 T4P GE0160 T4	GE0200 T4	GE0250 T4	GE0251 T4	GE0315 T4	GE0400 T4	GE0500 T4	GE0630 T4	GE0800 T4	GE1000 T4	GE1250 T4	GE1600 T4
CONTACT CHARACTERISTICS														
IEC conventional free air thermal current I _{th} (≤40°C)	A	160	200	250	250	315	400	500	630	800	1000	1250	1600	
IEC rated insulation voltage U _i	V	1000												
IEC rated impulse withstand U _{imp}	kV	8						12						
IEC rated operational current I _e														
AC21A	400V	A	160	200	200	250	315	400	500	630	800	1000	1250	1600
	500V	A	160	200	200	250	315	400	500	630	800	1000	1250	1600
	690V	A	160	180	180	200	250	250	500	630	800	1000	1000	1600
AC22A	400V	A	160	200	200	250	315	400	500	630	800	1000	1250	1600
	500V	A	160	200	200	250	315	400	500	630	800	1000	1000	1250
	690V	A	125	160	160	160	200	200	400	500	500	630	630	1000
AC23A	400V	A	160	160	160	250	315	400	500	630	800	1000	1000	1000
	500V	A	125	125	125	200	250	315	400	500	500	800	800	900
	690V	A	80	80	80	160	160	160	250	315	315	500	500	630
IEC reactive power for control of capacitors 400V senφ=0,65	kvar	72	72	72	112	142	180	225	284	284	360	360	450	
IEC rated operational power														
AC23A	400V	kW	90	90	90	138	174	220	220	349	443	443	554	
	690V	kW	75	75	75	153	153	153	239	300	300	478	600	
Short circuit protection														
Rated short-time current (1s) I _{cs}	kA rms	7			12			16			25		50	
Conditional short-circuit current ①	kA rms	100										72	72	
With fuse class gG	A	160	200	250			315	400	500	630	800	1000	1250	2x800
Making capacity AC23A 400V	A	1600			2500		3150	4000	5000	6300		8000	10000	
Breaking capacity AC23A 400V	A	1280			2000		2520	3200	4000	5000		6400	8000	
Mechanical life	cycles	30,000			20,000			10,000						
Electrical life (AC23A 400V)	cycles	1,000								500				
Terminals	type	Lug terminal ② or bars												
	A mm	18	26			25			25	30		40	60	
	B mm	3			4			5			8	10		
	screw	M8	M10						M14		M14			
Tightening torque	Nm	13④	18			24			45	55				
	lbft	10④	13			18			33	40				
Max. conductor section	mm ²	95	120		185		240	2x185	2x240		2x300		—	
Max. bar size (thickness-width)	mm	5-25⑥	5-30		7-25			6-40	2x 5-40		2x 10-50		2x 7-80	
AMBIENT CONDITIONS														
Temperature	Operating	°C	-25...+55											
	Storage	°C	-40...+70											
Maximum altitude	m	3000												
Mounting position	Normal		Vertical											
	Admissible		Any											
Fixing		Screw												

- ① With protection fuse limiting peak current and specific through energy.
- ② Not suitable for types GE0160 P and GE0160 T4P.
- ③ Types GE...P have hex terminals IP20.
- ④ 4Nm/3lbft only for types GE...P.
- ⑤ The 4-pole types (3P+N) have early-make late-break neutral pole.

Switch disconnectors

Technical characteristics

GE series 50A to 800A - Three pole and four pole with fuse holder

TYPE	NFC	3-pole	GE0050 F	GE0125 F	-	-	-	-	-	-	-
		4-pole ^②	GE0050 FT4	GE0125 FT4	-	-	-	-	-	-	-
BS	3-pole	-	-	GE0160 B	-	GE0200 B	GE0250 B	GE0315 B	GE0400 B	GE0630 B	GE0800 B
	4-pole ^②	-	-	GE0160 BT4	-	GE0200 BT4	GE0250 BT4	GE0315 BT4	GE0400 BT4	GE0630 BT4	GE0800 BT4
NH	3-pole	-	-	GE0160 N	GE0161 N	-	GE0250 N	-	GE0400 N	GE0630 N	GE0800 N
	4-pole ^②	-	-	GE0160 NT4	GE0161 NT4	-	GE0250 NT4	-	GE0400 NT4	GE0630 NT4	GE0800 NT4

CONTACT CHARACTERISTICS

IEC conventional free air thermal current I _{th} (≤40°C)	A	50	125	160	160	200	250	315	400	630	800	
IEC rated insulation voltage U _i	V	800	800	800			1000					
IEC rated impulse withstand U _{imp}	kV	8	8	8			12					
IEC rated operational current I _e												
AC21A	400V	A	50	125	160	160	200	250	315	400	630	800
	500V	A	50	125	160	160	200	250	315	400	630	800
	690V	A	50	125	160	160	200	250	315	400	630	630
AC22A	400V	A	50	125	160	160	200	250	315	400	630	800
	500V	A	50	125	160	160	200	250	315	400	630	800
	690V	A	50	100	125	160	200	250	315	400	630	630
AC23A	400V	A	50	125	160	160	200	250	315	400	630	630
	500V	A	50	125	125	160	200	250	315	400	630	630
	690V	A	50	80	100	125	160	200	250	315	400	400
Power dissipation	NFC	W/pole	4.7	12.5	—	—	—	—	—	—	—	
	BS	W/pole	—	—	12	—	13	12	24	29	44	63
	NH	W/pole	—	—	11,8	13,5	—	18,7	—	30	48	57
IEC reactive power for control of capacitors 400V	kvar	18	52	60	60	75	115	150	200	250	325	
IEC rated operational power AC23A	400V	kW	25	65	90	90	110	132	185	220	355	355
	690V	kW	42	80	90	110	132	160	200	250	370	370
Short circuit protection	Spec. through energy I ² t	kA ² s	0.076	0.19	0.19	0.478	0.478	1.6	1.6	1.6	4.6	4.6
	Conditional short circuit current	kA rms	50	50	100 ^①	100	100	100	100	100	100	100
Making capacity AC23A 400V	A	500	1250	1600			2000	2500	3150	4000	6300	
Breaking capacity AC23A 400V	A	400	1000	1280			1600	2000	2600	3200	5100	
Mechanical life	cycles	10,000	10,000				10,000			5,000		
Electrical life (AC23A 400V)	cycles	1,500	1,500				1,000			500		
Terminals	type			Lug terminal or bars								
	A mm	—	—	20	25		30		35	40	50	
	B mm	—	—	3			4		5	6		
Tightening torque	Nm	3	4	13			24		45		13	
	lbft	2,2	3	10			18		33		10	
Max. conductor section	mm ²	35	93	95	120		240		2x185		2x240	
Max. bar size (thickness-width)	mm	—	—	3-25	5-25		6-40		2x 7-50		2x 7-50	

AMBIENT CONDITIONS

Temperature	Operating	°C	-25...+55								
	Storage	°C	-40...+70								
Maximum altitude	m	3000									
Mounting position	Normal	Vertical									
	Admissible	Any									
Fixing	Screw										

① 50kA rms for types GE0160 N and GE0160 NT4.

② Types GE...F have hex terminals IP20.

③ The 4-pole types (3P+N) have early-make late-break neutral pole.

Switch disconnectors

Technical characteristics

GE series 160A to 1600A - Three and four-pole switches

TYPE	3-pole	GE0160 E	GE0200 E	GE0201 E	GE0250 E	GE0315 E	GE0400 E	GE0500 E	GE0630 E	GE0800 E	GE1000 E	GE1250 E	GE1600 E	
	4-pole ②	GE0160 ET4	GE0200 ET4	GE0201 ET4	GE0250 ET4	GE0315 ET4	GE0400 ET4	GE0500 ET4	GE0630 ET4	GE0800 ET4	GE1000 ET4	GE1250 ET4	GE1600 ET4	
CONTACT CHARACTERISTICS														
IEC conventional free air thermal current I _{th} (≤40°C)	A	160	200	250	315	400	500	630	800	1000	1250	1600		
IEC rated insulation voltage U _i	V	1000						1000						
IEC rated impulse withstand U _{imp}	kV	8						12						
IEC rated operational current I _e														
AC21A	400V	A	160	200	200	250	315	400	500	630	800	1000	1250	1600
	500V	A	160	200	200	250	315	400	500	630	800	1000	1250	1600
	690V	A	160	200	200	250	315	400	500	630	800	1000	1250	1600
AC22A	400V	A	160	200	200	250	315	400	500	630	800	1000	1250	1600
	500V	A	160	200	200	250	315	400	500	630	800	1000	1250	1250
	690V	A	125	160	160	200	250	315③	400	500	630③	800	1000③	1000
AC23B	400V	A	160	160	160	180	200	250	400	500	630	1000	1000	1000
	500V	A	125	125	125	150	160	200	250	315	400	800	900	900
	690V	A	80	80	80	100	125	160	250	250	315	630	630	630
Power dissipation	W/pole	4	6	8	8,5	13,5	22	28	44,5	72	76	118	128	
IEC reactive power for control of capacitors 400V	kvar	72	72	83	104	131	166	208	262	333	415	415	450	
IEC rated operational power AC23A	400V	kW	89	89	100	100	125	125	200	200	315	500	525	550
	690V	kW	76	76	69	86	108	138	173	216	272	544	575	600
Short circuit protection														
Rated short-time current (1s) I _{cs}	kA rms	7	7	8				13				25	35	
Conditional short-circuit current ①	kA rms	100	100	100						72				
With fuse class gG	A	160	200	250		315	400	500	630	800	1000	1250	2x800	
Making capacity AC23A 400V	A	1600	1600	3150		4000		6300		8000	10000	10000	10000	
Breaking capacity AC23A 400V	A	1280	1280	2520		3200		5040		6400	8000	8000	8000	
Mechanical life	cycles	30,000	30,000	10,000				10,000						
Electrical life (AC22A 400V)	cycles	1,000	1,000	1,000				500						
Terminals	type	Lug terminal or bars												
	A mm	18	26	25			35	40			50	60		
	B mm	3	3						5			6	10	
	screw	M8	M10				M12			M14	M14			
Tightening torque	Nm	13	24						45			55		
	lbft	10	18						33			40		
Max. conductor section	mm ²	95	120	240			2x240			-	-	-		
Max. bar size (thickness-width)	mm	4-13	13-18	2x 5-30			2x 6-45			2x 10-60		2x 7-80		
AMBIENT CONDITIONS														
Temperature	Operating	°C		-25...+55										
	Storage	°C		-40...+70										
Maximum altitude	m		3000											
Mounting position	Normal	Vertical												
	Admissible	Any												
Fixing	Screw													

① With protection fuse limiting peak current and specific through energy.

② The 4-pole types (3P+N) have early-make late-break neutral pole.

③ Value in AC22B.

Switch disconnectors

Technical characteristics

GA and GD series for photovoltaic applications

TYPE	Three-pole	GA040 D	GD025 AT2	GD032 AT3	GD040 AT4	
	4th-pole	GAX42 040 D	—	—	—	
CONTACT CHARACTERISTICS						
IEC conventional free air thermal current I _{th} (≤40°C)	A	40	25	32	40	
IEC rated insulation voltage U _i	V	1000	1000 / 1500 ^①			
IEC rated impulse withstand U _{imp}	kV	8				
IEC rated operational current I _e DC21B						
2 poles in series	300V	A	16	25	32	40
3 poles in series	48V	A	40	25	32	40
	110V	A	35	25	32	40
	220V	A	32	25	32	40
	500V	A	12	25	32	40
4 poles in series	400V	A	35	25	32	40
	440V	A	32	25	32	40
	500V	A	32	25	32	40
	600V	A	20	25	32	40
	700V	A	15	25	32	40
	750V	A	15	25	32	40
	800V	A	15	25	32	40
	1000V	A	—	16	32	40
1200V	A	—	—	—	32	
Power dissipation		1	1.2	2.8	5.8	
Mechanical life	cycles	100,000	10,000			
Terminals	type	Mantle	Screw with washer			
	A mm	5,6	—			
	B mm	6,5	—			
	Screw	M4	—			
	Tool	Phillips 2	Phillips 1			
Tightening torque	Nm	1.8...2	1.2...1.6			
	lbin	16...18	10...14			
Conductor section min.-max.	mm ²	0.75...16	1...10			
	AWG	18...6	18...8			
AMBIENT CONDITIONS						
Temperature	Operating	°C	-25...+55			
	Storage	°C	-40...+70			
Maximum altitude	m	3.000	2.000			
Mounting position	Normal		Vertical			
	Admissible		Any			
Fixing		Screw or 35mm DIN rail (IEC/EN 60715)				

① 1000V pollution degree 3; 1500V pollution degree 2.

Switch disconnectors

Technical characteristics

GE series for photovoltaic applications

TYPE	4-pole	GE0125 DT4	GE0250 DT4	GE0315 DT4	
CONTACT CHARACTERISTICS					
IEC conventional free air thermal current I _{th} (≤40°C)	A	125	250	315	
IEC rated insulation voltage U _i	V	1000			
IEC rated impulse withstand U _{imp}	kV	8			
IEC rated operational current I _e DC21B	48V A	125	250	315	
4 poles in series	110V A	125	250	315	
	220V A	125	250	315	
	400V A	125	250	315	
	440V A	125	250	315	
	500V A	125	250	315	
	600V A	125	250	315	
	750V A	125	250	290	
	800V A	125	250	280	
	850V A	125	240	270	
	900V A	125	220	260	
	1000V A	100	200	250	
Mechanical life	cycles	20,000			
Terminals		type	Lug terminal ② or bars		
		A mm	20	25	25
		B mm	4	4	4
		vite	M8	M10	M10
Tightening torque	Nm	13	18	18	
	lbft	10	13	13	
Max. bar size (thickness-width)	mm	7-25			
Max. conductor section	mm ²	185			
AMBIENT CONDITIONS					
Temperature	Operating	°C	-25...+55		
	Storage	°C	-40...+70		
Maximum altitude	m	3000			
Mounting position	Normal	Vertical			
	Admissible	Any			
Fixing		Screw			

- ① 4Nm/3lbft only for GE0160 DT4P.
- ② GE0160 DT4P has pillar terminal, IP20.
- ③ Not suitable for type GE0160 DT4P.

Switch disconnectors

Technical characteristics

GE series for photovoltaic applications

GE0630 DT4	GE0800 DT4	GE1250 DT4
630	800	1250
	1000	
	12	
630	800	1250
630	800	1250
630	800	1250
630	800	1250
630	750	1250
630	700	1250
630	700	1250
630	650	1050
600	630	1000
600	630	940
600	630	870
500	630	850
	10,000	
	Lug terminal ② or bars	
30	30	40
5	5	8
M10	M10	M14
24	24	45
18	18	33
2x 5-40 (thickness-width)	2x 5-40	2x 10-50
2x240	2x240	2x300
	-25...+55	
	-40...+70	
	3000	
	Vertical	
	Any	
	Screw	

- ① 4Nm/3lbf only for GE0160 DT4P.
- ② GE0160 DT4P has pillar terminal, IP20.
- ③ Not suitable for type GE0160 DT4P.