

# Fișă tehnică produs

Specificatii



## Releu de Temporizare 10 Functii, 1 S, 100 H, 12, 240 V Ca/Cc, 1 Id

RE17RMMWS

### Principale

gama de produse	Harmony Timer Relays
tip de iesire discreta	Releu
Tip produs sau componenta	Releu de sincronizare modular
latime	17,5 mm
nume scurt al dispozitivului	RE17R
tip intarziere	Power on-delay On-delay and off-delay Interval Temporizare la revenire Symmetrical flashing
intervalul de intarziere	6...60 min 6...60 s 1...10 min 1...10 H 0.1...1 s 10...100 H 1...10 s
curent nominal de iesire	8 A

### Suplimentare

tip si compozitie contacte	1 C/O
Material contacte	Fara cadmiu
inaltime	90 mm
adancime	72 mm
tip de control	Selector panou frontal
[Us] tensiune nominala de alimentare	12...240 V c.a./c.c. 50/60 Hz
interval de tensiune	0,85...1,1 Us
frecventa de alimentare	50...60 Hz +/- 5 %
release of input voltage	5 V
conexiuni - borne	Borne cu arc, 2 x 0.2 - 2 x 1.5 mm <sup>2</sup> (AWG 24 - AWG 16) solid fara terminale de cablu Borne cu arc, 2 x 0.2 - 2 x 1.5 mm <sup>2</sup> (AWG 24 - AWG 16) flexibil cu pini
material carcasa	Policarbonat
precizie de repetare	+/- 0,5 % conformitate cu IEC 61812-1
Abatere temperatura	+/- 0,05 %/°C
abatere a tensiunii	+/- 0,2 %/V
setarea preciziei temporizarii	+/- 10 % din capatul scarii la 25 °C conformitate cu IEC 61812-1

<b>Time delay type</b>	Power on-delay - A- Power on-delay relay On-delay and off-delay - Ac- On-delay and off-delay relay w/ control signal Power on-delay - At- Power on-delay relay w/ pause/summation (Y1) Interval - B- Single interval relay w/ control signal Interval - Bw- Double interval relay w/ control signal Temporizare la revenire - C- Off-delay relay w/ control signal Symmetrical flashing - D- Symmetrical flashing relay (starting pulse-off) Symmetrical flashing - Di- Symmetrical flashing relay (starting pulse-on) Interval - H- Interval relay Interval - Ht- Interval relay w/ pause/summation (Y1)
<b>control signal pulse width</b>	100 ms cu sarcina în paralel tipic 30 ms tipic
<b>rezistența de izolație</b>	100 MΩ la 500 V c.c. conformitate cu SR EN 60664-1
<b>resetare timp</b>	120 ms la întreruperea alimentării tipic
<b>factor de sarcina</b>	100 %
<b>puterea consumată în VA</b>	0...3 VA la 240 V c.a.
<b>consum de putere maxim în W</b>	1,5 W la 240 V c.c.
<b>curentul minim de comutare</b>	10 mA la 5 V c.c.
<b>curent maxim de comutație</b>	8 A c.a./c.c.
<b>tensiunea maximă de comutație</b>	250 V c.a.
<b>capacitate de rupere</b>	2000 VA
<b>operating frequency</b>	10 Hz
<b>durabilitate electrică</b>	100000 cic pentru rezistiv sarcina (8 A la 250 V c.a. maxim)
<b>durabilitate mecanică</b>	10000000 cic
<b>rigiditate dielectrică</b>	2,5 kV 1 mA/1 minut 50 Hz conformitate cu IEC 61812-1
<b>[Uimp] tensiune de tinere la impuls</b>	5 kV în timpul 1.2/50 μs
<b>power on delay</b>	100 ms
<b>marcaj</b>	CE
<b>distanța de conturare</b>	4 kV/3 conformitate cu SR EN 60664-1
<b>fiabilitate securitate date</b>	MTTFd = 296.8 ani B10d = 270000
<b>poziția de montaj</b>	Orice poziție în raport cu planul normal vertical de montare
<b>suport de montare</b>	Sina DIN 35 mm conformitate cu IEC 60715
<b>semnalizare locală</b>	Indicator cu LED pentru la funcționare stabilă: releu alimentat, fără temporizare în curs Indicator cu LED 80 % ON și 20 % OFF pentru intermitent: temporizare în curs Indicator cu LED 5 % ON și 95 % OFF pentru impulsuri: releu nealimentat, fără tempo. în progres (excepție funcția Di-D, Li-L)
<b>funcție disponibilă</b>	A- Power on-delay relay-1 C/O Ac- On-delay and off-delay relay w/ control signal-1 C/O At- Power on-delay relay w/ pause/summation (Y1)-1 C/O B- Single interval relay w/ control signal-1 C/O Bw- Double interval relay w/ control signal-1 C/O C- Off-delay relay w/ control signal-1 C/O D- Symmetrical flashing relay (starting pulse-off)-1 C/O Di- Symmetrical flashing relay (starting pulse-on)-1 C/O H- Interval relay-1 C/O Ht- Interval relay w/ pause/summation (Y1)-1 C/O
<b>greutate produs</b>	0,07 kg
<b>tip de control</b>	Without test button
<b>Number of functions</b>	10
<b>time delay type</b>	A, Ac, At, B, Bw, C, D, Di, H, Ht

functionalitate	Multifuncție
Cod compatibilitate	RE17

## Mediu

imunitate la microîntreruperi	20 ms
standarde	2006/95/EC IEC 61000-6-4 2004/108/EC IEC 61000-6-3 IEC 61812-1 IEC 61000-6-2 IEC 61000-6-1
certificari produs	GL cULus CSA
temperatura ambietala pentru depozitare	-30...60 °C
temperatura ambietala de functionare	-20...60 °C
grad de protectie IP	IP20 conformitate cu SR EN 60529 (cutie de borne) IP40 conformitate cu SR EN 60529 (carcasă) IP50 conformitate cu SR EN 60529 (panou frontal)
rezistenta la vibratii	20 m/s <sup>2</sup> (f= 10...150 Hz) conforming to IEC 60068-2-6
rezistenta la socuri	15 gn pentru 11 ms conformitate cu IEC 60068-2-27
umiditate relativa	93 % fără condensare conformitate cu IEC 60068-2-30
compatibilitate electromagnetica	Test de imunitate la descarcari electrostatice nivel de test: 6 kV (în contact) nivel 3 conformitate cu IEC 61000-4-2 Test de imunitate la descarcari electrostatice nivel de test: 9 kV (în aer) nivel 3 conformitate cu IEC 61000-4-2 Sensibilitate la câmpuri electromagnetice nivel de test: 10 V/m (80 MHz la 1 GHz) nivel 3 conformitate cu IEC 61000-4-3 Tranzienți rapizi/test de imunitate la impulsuri de ionizare nivel de test: 1 kV (brida de conectare capacitiva) nivel 3 conformitate cu IEC 61000-4-4 Tranzienți rapizi/test de imunitate la impulsuri de ionizare nivel de test: 2 kV (direct) nivel 3 conformitate cu IEC 61000-4-4 1.2/50 μs test de imunitate la undă de șoc nivel de test: 1 kV (mod diferential) nivel 3 conformitate cu IEC 61000-4-5 1.2/50 μs test de imunitate la undă de șoc nivel de test: 2 kV (mod comun) nivel 3 conformitate cu IEC 61000-4-5 Perturbații conduse de RF nivel de test: 10 V (0.15 - 80 MHz) nivel 3 conformitate cu IEC 61000-4-6 Test de imunitate la căderi de tensiune și întreruperi nivel de test: 1 % (1 ciclu) conformitate cu IEC 61000-4-11 Test de imunitate la căderi de tensiune și întreruperi nivel de test: 71 % (25/30 cicluri) conformitate cu IEC 61000-4-11 Emisii conduse și radiateclasa B conformitate cu EN 55022

## Unitati de ambalare

Unitate de masura pentru prima forma de impachetare	PCE
Număr de produse în pachet	1
Inaltime prima forma de impachetare	2,7 cm
Latime prima forma de impachetare	7,8 cm
Lungime prima forma de impachetare	9,5 cm
Greutate colet(Lbs)	75 g
Unitate de masura pentru a doua forma de impachetare	S02
Numar unitati in a doua forma de impachetare	40
Inaltime a doua forma de impachetare	15 cm

---

Latime a doua forma de impachetare	30 cm
------------------------------------	-------

---

Lungime a doua forma de impachetare	40 cm
-------------------------------------	-------

---

Greutate a doua forma de impachetare	3,484 kg
--------------------------------------	----------

---

## Garanție contractuală

---

Garantie (in luni)	18
--------------------	----

Schneider Electric isi propune sa atinga nivelul Net Zero pana in 2050 prin parteneriate la nivelul lantului de aprovizionare, materiale cu impact mai redus si circularitate, prin campania „Use Better, Use Longer, Use Again” pentru a extinde durata de viata a produselor si reciclabilitatea.

[Environmental Data explicate >](#)

[Cum evaluam sustenabilitatea produselor >](#)

### **Amprenta de mediu**

Amprenta de carbon totala pe durata de viata	43 kg CO2 eq.
Amprenta de carbon a fazei de fabricație [A1–A3]	2 kg CO2 eq.
Amprenta de carbon a fazei de distribuție [A4]	0.1 kg CO2 eq.
Amprenta de carbon a fazei de instalare [A5]	0 kg CO2 eq.
Amprenta de carbon a fazei de utilizare [B2, B3, B4, B6]	41 kg CO2 eq.
Amprenta de carbon a fazei de sfârșit de viață [C1–C4]	0.2 kg CO2 eq.
Raport de mediu	<a href="#">Profilul ambiental al produsului</a>

### **Use Better**

#### **Materiale si ambalare**

Pachet cu carton reciclabil	Da
Ambalaj fara plastic	Da
Numar SCIP	7bdc2711-0ad2-427c-8ece-532c5e9f09d7
Directiva RoHS a UE	<a href="#">Conform Prin Scutire</a>
Regulamentul REACH	<a href="#">Referința conține SVHC peste prag</a>

### **Use Longer**

#### **Prelungire durata de viata**

Reparare	Nu
----------	----

### **Use Again**

#### **Reambalare si refabricare**

Potentialul de reciclabilitate, in %	13
Profil circularitate	<a href="#">Informatii privind sfarsitul duratei de viata</a>
Preluare la sfarsitul duratei de viata	Da

Dimensions Drawings

Width 17.5 mm

---

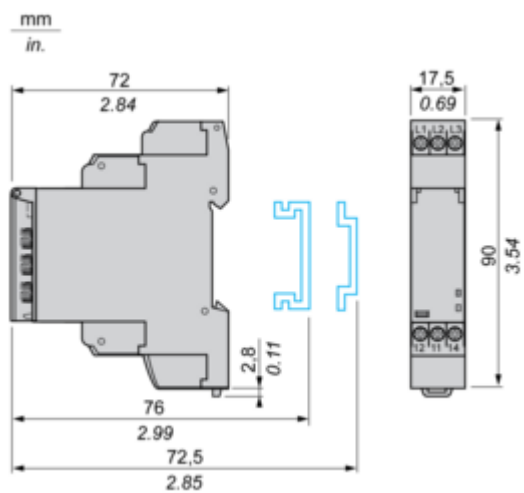

Connections and Schema

Internal Wiring Diagram

---

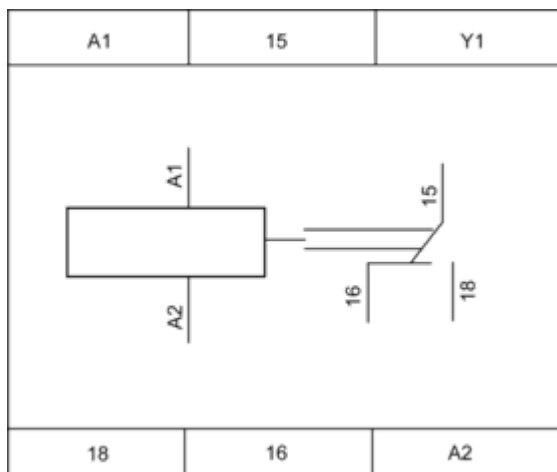

Wiring Diagram

---

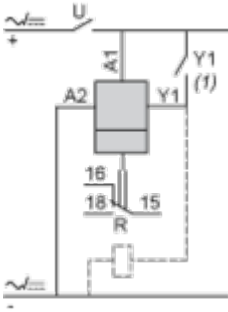

## 1) Contact Y1:

- Control for functions B, C, Ac, Bw, Ad, Ah, N, O, W, T, Tt.
- Partial stop for functions At, Ht and Pt.
- Function D if Di selected.
- Not used for functions A, H and P.

Technical Description

**Function A : Power on Delay Relay**

---

**Description**

The timing period T begins on energisation. After timing, the output(s) R close(s). The second output can be either timed or instantaneous.

**Function: 1 Output**

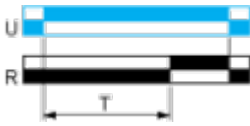

**Function: 2 Outputs**

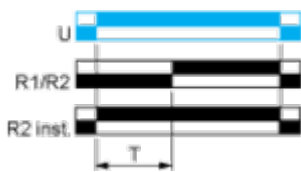

2 timed outputs (R1/R2) or 1 timed output (R1) and 1 instantaneous output (R2 inst.)

**Function Ac: On-Delay & Off-Delay with Control Signal**

---

**Description**

After energisation of power supply and energization of Y1 causes the timing period T to start.

At the end of this timing period, the output(s) R close(s).

When deenergization of Y1, the timing T starts.

At the end of this timing period T, the output(s) R revert(s) to its/their initial position.

The second output (R2) can be either timed (when set to "TIMED") or instantaneous (when set to "INST").

**Function: 1 Output**

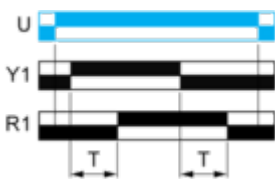

**Function: 2 Outputs**

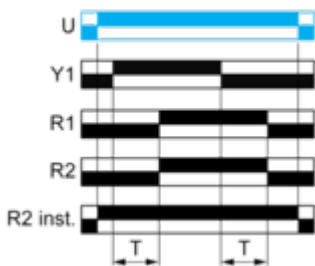

**Function At : Power on Delay Relay (Summation) with Control Signal**

---

**Description**

After power-up, the first opening of control contact C starts the timing. Timing can be interrupted each time control contact closes. When the cumulative total of time periods elapsed reaches the pre-set value T, the output relay closes.

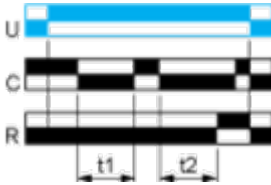
**Function: 1 Output**

$$T = t1 + t2 + \dots$$

**Function B : Interval Relay with Control Signal**

---

**Description**

After power-up, pulsing or maintaining control contact C starts the timing T. The output R closes for the duration of the timing period T then reverts to its initial state.

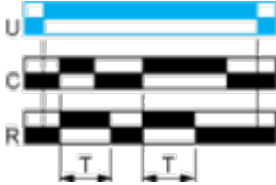
**Function: 1 Output**

**Function Bw : Double Interval Relay with Control Signal**

---

**Description**

On closing and opening of control contact C, the output R closes for the duration of the timing period T.

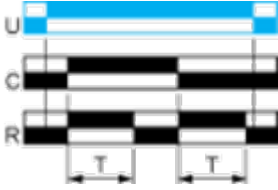
**Function: 1 Output**

**Function C : Off-Delay Relay with Control Signal**

---

**Description**

After power-up and closing of the control contact C, the output R closes. When control contact C re-opens, timing T starts. At the end of the timing period, the output(s) R revert(s) to its/their initial state. The second output can be either timed or instantaneous.

**Function: 1 Output**

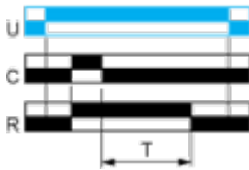

**Function: 2 Outputs**

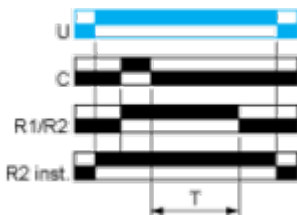

2 timed outputs (R1/R2) or 1 timed output (R1) and 1 instantaneous output (R2 inst.)

**Function D: Symmetrical Flashing Relay (Starting Pulse Off)**

**Description**

On energisation of power supply, output(s) R starts at its/their initial state for timing duration T then change(s) to output(s) R close(s) for the same timing duration T. This cycle is repeated indefinitely until power supply removal. Specially for RE17\*, RE22R2AMU, RE22R2MMW, RE22R2MMU, RE22R2MJU, this D function can only be initiated by energizing Y1 permanently. The second output (R2) can be either timed (when set to "TIMED") or instantaneous (when set to "INST").

**Function: 1 Output**



**Function: 2 Outputs**

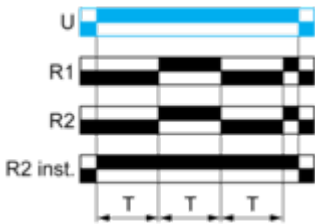

**Function: 1 Output with Retrigger / Restart Control**

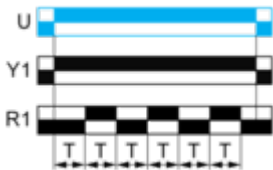

**Function: 2 Output with Retrigger / Restart Control**

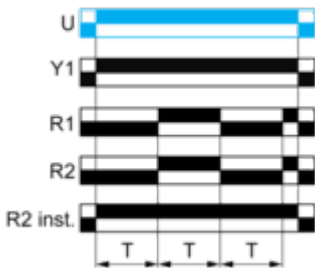

**Function Di : Symmetrical Flasher Relay (Starting Pulse On)**

---

**Description**

Repetitive cycle with two timing periods T of equal duration, with output(s) R changing state at the end of each timing period T.

The second output can be either timed or instantaneous.

**Function: 1 Output**

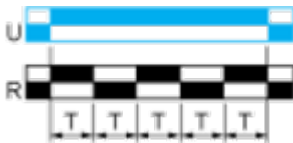

**Function: 2 Outputs**

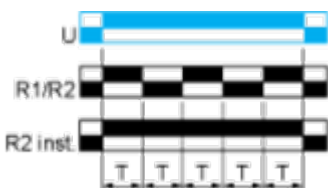

2 timed outputs (R1/R2) or 1 timed output (R1) and 1 instantaneous output (R2 inst.)

**Function H : Interval Relay**

---

**Description**

On energisation of the relay, timing period T starts and the output(s) R close(s). At the end of the timing period T, the output(s) R revert(s) to its/their initial state. The second output can be either timed or instantaneous.

**Function: 1 Output**



**Function: 2 Outputs**

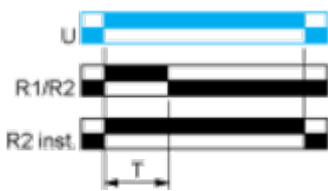

2 timed outputs (R1/R2) or 1 timed output (R1) and 1 instantaneous output (R2 inst.)

**Function Ht: Interval Relay & With Pause / Summation Control**

**Description**

On energisation of power supply, output(s) R close(s) and timing period T starts.

The timing can be interrupted / paused each time X1 energizes.

When the cumulative total of time periods elapsed reaches the pre-set value T, the output(s) R revert(s) to its/their initial state. Reenergization of X1 will also cause output(s) R close(s) if the time has elapsed and restart the same operation as described at the beginning.

Except for RE17\*, RE22R2MMW, RENF22R2MMW, RE22R2MMU and RE22R2MJU, timing can be interrupted / paused each time Y1 energizes.

The second output (R2) can be either timed (when set to "TIMED" or instantaneous (when set to "INST").

**Function: 1 Output**

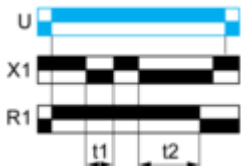

$T = t1 + t2 + \dots$

**Function: 2 Outputs**

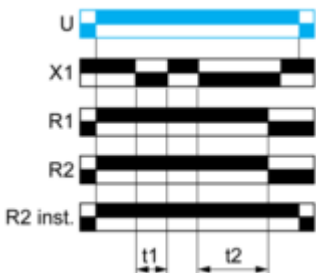

$T = t1 + t2 + \dots$

**Function: 1 Output with Retrigger / Restart Control**

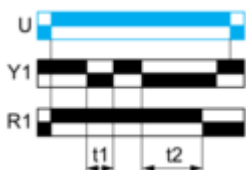

$T = t1 + t2 + \dots$



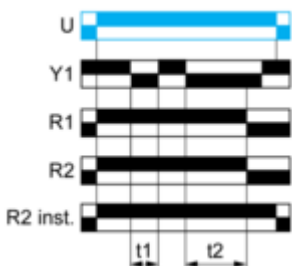

**Function: 2 Outputs with Retrigger / Restart Control**



$T = t1 + t2 + \dots$

**Legend**

---

	Relay de-energised
	Relay energised
	Output open
	Output closed

C	Control contact
G	Gate
R	Relay or solid state output
R1/R2	2 timed outputs
R2 inst.	The second output is instantaneous if the right position is selected
T	Timing period
Ta -	Adjustable On-delay
Tr -	Adjustable Off-delay
U	Supply

Technical Illustration

Dimensions

---

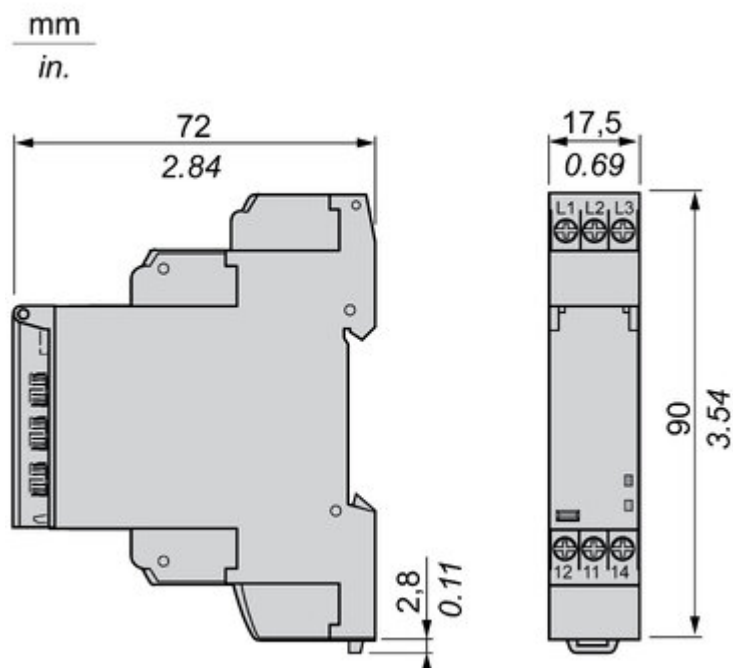

Offer Marketing Illustration

Product benefits / Features

---

## Technical Benefits

### Harmony Timer Relay

Flexible choice of screw or spring connection terminals for wiring.

One product reference covering 28 timing functions, 2 outputs, and a wide range of supply voltage 24...240 V AC/DC.

Dust and unintended human intervention avoided thanks to the IP50 lead-sealable settings protection cover.

A Dial-Pointer LED indicator that enhances ease of operation in difficult environments such as dusty or low-light conditions

Different mounting style to meet your preference:  
DIN rail mount with product width; 17.5 mm/0.69 in.  
22.5 mm/0.88 in.  
Plug in mounting with socket

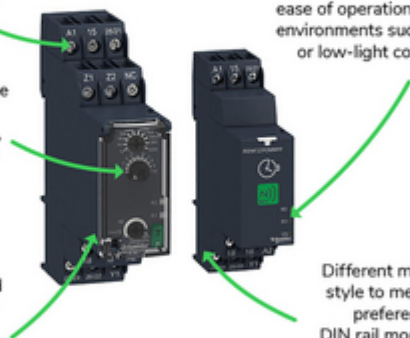

Offer Marketing Illustration

Product benefits / Features

---



### Features

#### Harmony Timer Relay

-  "Diagnostic button" to check downstream circuit immediately, shorten the commission and troubleshooting time
-  Compatible with a wide range of applications including machines, buildings, water segments, and HVAC.
-  Wide range of time delay for adjustment: from 0.01 s to 999 hrs.
-  Compliant with IEC 60255-1 standard, and a wide array of product certifications such as UL, CE, CSA, EAC.
-  Unprecedented accuracy, predictive maintenance, and superior security.

Image of product / Alternate images

Alternative

---

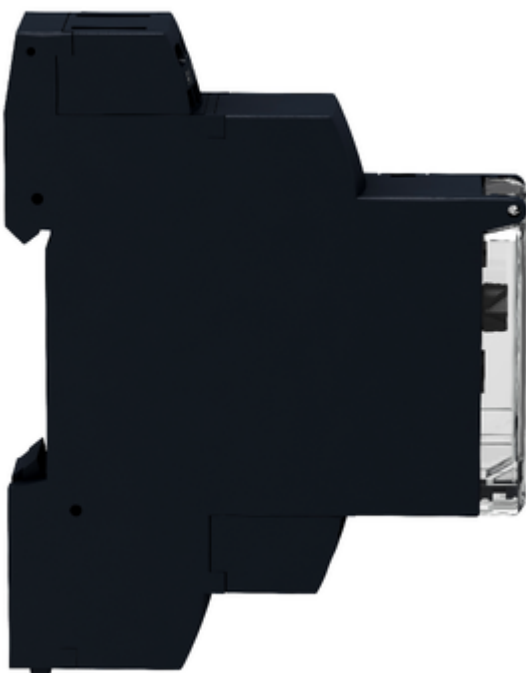





Image of product in real life situation

