

# Product data sheet

Specifications



Push button flush mounted,  
Harmony XB5, plastic, black, 30mm,  
spring return, unmarked, 1NO

XB5FA21

## Main

Range of product	Harmony XB5
Product or component type	Push-button
Device short name	XB5F
Product compatibility	ZBYF2101 ZBYF4101 ZBYF6101 ZBYF6102 ZBZF32 ZBZF33 ZB4FBZ007
Bezel material	Plastic Dark grey plastic
Head type	Built-in-flush
Fixing collar material	Plastic
Mounting diameter	30.5 mm
Sale per indivisible quantity	1
Shape of signaling unit head	Round
Type of operator	spring return
Operator profile	Black flush, unmarked
Contacts type and composition	1 NO
Contact operation	Slow-break
Connections - terminals	Screw clamp terminals, $\leq 2 \times 1.5 \text{ mm}^2$ with cable end conforming to IEC 60947-1 Screw clamp terminals, $1 \times 0.22 \dots 2 \times 2.5 \text{ mm}^2$ without cable end conforming to IEC 60947-1 Screw clamp terminals, $\geq 1 \times 0.22 \text{ mm}^2$ without cable end conforming to IEC 60947-1

## Complementary

Height	42 mm
Width	36.6 mm
Depth	55 mm
Terminals description ISO n°1	(13-14)NO
Resistance to high pressure washer	7000000 Pa at 55 °C, distance : 0.1 m
Contacts usage	Standard contacts
Positive opening	Without
Operating travel	2.6 mm (NO changing electrical state) 4.3 mm (total travel)

<b>Operating force</b>	3.8 N NO changing electrical state
<b>Mechanical durability</b>	10000000 cycles
<b>Tightening torque</b>	0.8...1.2 N.m conforming to IEC 60947-1
<b>Shape of screw head</b>	Cross compatible with Philips no 1 screwdriver Cross compatible with pozidriv No 1 screwdriver Slotted compatible with flat Ø 4 mm screwdriver Slotted compatible with flat Ø 5.5 mm screwdriver
<b>Contacts material</b>	Silver alloy (Ag/Ni)
<b>Short-circuit protection</b>	10 A cartridge fuse type gG conforming to IEC 60947-5-1
<b>[Ith] conventional free air thermal current</b>	10 A conforming to IEC 60947-5-1
<b>[Ui] rated insulation voltage</b>	600 V (pollution degree 3) conforming to IEC 60947-1
<b>[Uimp] rated impulse withstand voltage</b>	6 kV conforming to IEC 60947-1
<b>[Ie] rated operational current</b>	3 A at 240 V, AC-15, A600 conforming to IEC 60947-5-1 6 A at 120 V, AC-15, A600 conforming to IEC 60947-5-1 0.1 A at 600 V, DC-13, Q600 conforming to IEC 60947-5-1 0.27 A at 250 V, DC-13, Q600 conforming to IEC 60947-5-1 0.55 A at 125 V, DC-13, Q600 conforming to IEC 60947-5-1 1.2 A at 600 V, AC-15, A600 conforming to IEC 60947-5-1
<b>Electrical durability</b>	1000000 cycles AC-15, 2 A at 230 V, operating rate <3600 cyc/h, load factor: 0.5 conforming to IEC 60947-5-1: appendix C 1000000 cycles AC-15, 3 A at 120 V, operating rate <3600 cyc/h, load factor: 0.5 conforming to IEC 60947-5-1: appendix C 1000000 cycles AC-15, 4 A at 24 V, operating rate <3600 cyc/h, load factor: 0.5 conforming to IEC 60947-5-1: appendix C 1000000 cycles DC-13, 0.2 A at 110 V, operating rate <3600 cyc/h, load factor: 0.5 conforming to IEC 60947-5-1: appendix C 1000000 cycles DC-13, 0.5 A at 24 V, operating rate <3600 cyc/h, load factor: 0.5 conforming to IEC 60947-5-1: appendix C
<b>Electrical reliability</b>	$\Lambda < 10^{\exp(-6)}$ at 5 V and 1 mA in clean environment conforming to IEC 60947-5-4 $\Lambda < 10^{\exp(-8)}$ at 17 V and 5 mA in clean environment conforming to IEC 60947-5-4
<b>Device presentation</b>	Complete product
<b>Customizable</b>	No
<b>Customizable</b>	1
<b>GCR BRIDGE</b>	XB5FACUST01
<b>Compatibility code</b>	XB5

## Environment

<b>Protective treatment</b>	TH
<b>Ambient air temperature for storage</b>	-40...70 °C
<b>Ambient air temperature for operation</b>	-40...70 °C
<b>Overvoltage category</b>	Class II conforming to IEC 60536
<b>IP degree of protection</b>	IP66 conforming to IEC 60529 IP67 IP69 IP69K Type 13 conforming to UL 50 E Type 12 conforming to UL 50 E Type 4 conforming to UL 50 E Type 4X conforming to UL 50 E
<b>Enclosure Type</b>	UL type 4X/13
<b>IK degree of protection</b>	IK03 conforming to IEC 50102

<b>Standards</b>	IEC 60947-1 UL 508 JIS C8201-5-1 IEC 60947-5-4 IEC 60947-5-1 CSA C22.2 No 14 JIS C8201-1 ISO 22196:2011 ISO 21702
<b>Product certifications</b>	UL listed CSA
<b>Vibration resistance</b>	5 gn (f= 2...500 Hz) conforming to IEC 60068-2-6 2 mm peak to peak (f= 2...10 Hz) conforming to IEC 60068-2-6
<b>Shock resistance</b>	30 gn (duration = 18 ms) for half sine wave acceleration conforming to IEC 60068-2-27 50 gn (duration = 11 ms) for half sine wave acceleration conforming to IEC 60068-2-27 25 gn (duration = 6 ms) for 1000 shocks on each axis conforming to IEC 60068-2-27

## Packing Units

<b>Unit Type of Package 1</b>	PCE
<b>Number of Units in Package 1</b>	1
<b>Package 1 Height</b>	4.3 cm
<b>Package 1 Width</b>	5.3 cm
<b>Package 1 Length</b>	8.8 cm
<b>Package 1 Weight</b>	43.0 g
<b>Unit Type of Package 2</b>	S02
<b>Number of Units in Package 2</b>	40
<b>Package 2 Height</b>	15 cm
<b>Package 2 Width</b>	30 cm
<b>Package 2 Length</b>	40 cm
<b>Package 2 Weight</b>	2.005 kg

## Contractual warranty

<b>Warranty (in months)</b>	18
-----------------------------	----



## Environmental Data

Schneider Electric aims to achieve Net Zero status by 2050 through supply chain partnerships, lower impact materials, and circularity via our ongoing “Use Better, Use Longer, Use Again” campaign to extend product lifetimes and recyclability.

[Environmental Data explained >](#)

[How we assess product sustainability >](#)



### Environmental footprint

Total lifecycle Carbon footprint	0.5 kg CO2 eq.
Carbon footprint of the manufacturing phase [A1 to A3]	0.3 kg CO2 eq.
Carbon footprint of the distribution phase [A4]	0 kg CO2 eq.
Carbon footprint of the installation phase [A5]	0 kg CO2 eq.
Carbon footprint of the use phase [B2, B3, B4, B6]	0 kg CO2 eq.
Carbon footprint of the end-of-life phase [C1 to C4]	0.1 kg CO2 eq.

## Use Better



### Materials and Substances

Average percentage of recycled plastic content	14 %
Average percentage of recycled metal content	13 %
Packaging made with recycled cardboard	Yes
Packaging without single use plastic	Yes
EU RoHS Directive	<a href="#">Compliant</a>
REACH Regulation	<a href="#">Reference contains Substances of Very High Concern above the threshold</a>
California proposition 65	<b>WARNING:</b> This product can expose you to chemicals including: Nickel compounds, which is known to the State of California to cause cancer, and Di-isodecyl phthalate (DIDP), which is known to the State of California to cause birth defects or other reproductive harm. For more information go to <a href="http://www.P65Warnings.ca.gov">www.P65Warnings.ca.gov</a>

## Use Longer



### Lifetime extension

Repair	No
Product repair index	<a href="#">A</a>

## Use Again



### Repack and remanufacture

Recyclability potential, in %	0
End of life manual availability	<a href="#">End of Life Information</a>
Take-back	No
WEEE Label	 The product must be disposed on European Union markets following specific waste collection and never end up in rubbish bins

Dimensions Drawings

Dimensions

---

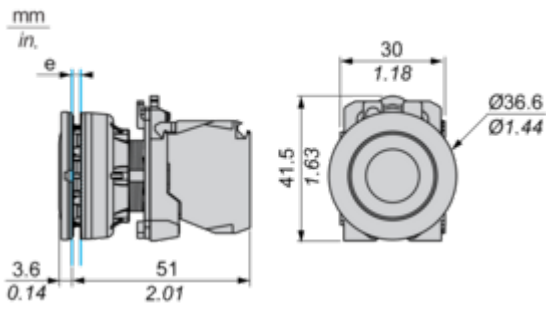

e: Clamping thickness: 1 to 6 mm / 0.04 to 0.24 in.

Mounting and Clearance

Panel Cut-out for Pushbuttons, Switches and Pilot Lights (Finished Holes, Ready for Installation)

---

Connection by Screw Clamp Terminals or Plug-in Connectors

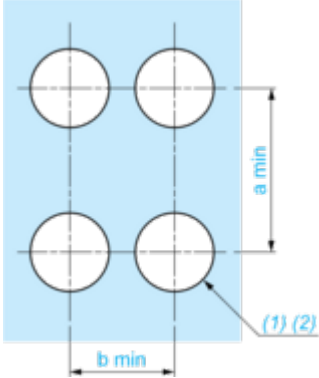

(1) Diameter on finished panel or support

(2)  $\text{Ø}30.75 \text{ mm}$  recommended ( $\text{Ø}30.5 \text{ }_0^{+0.5}$ ) /  $\text{Ø}1.21 \text{ in.}$  recommended ( $\text{Ø}1.20 \text{ in. }_0^{+0.0196}$ )

Connections	a in mm	a in in.	b in mm	b in in.
By screw clamp terminals or plug-in connector	40	1.57	40	1.57
By Faston connectors	45	1.77	40	1.57

Technical Description

Electrical Composition Corresponding to Code C1

---



Electrical Composition Corresponding to Code C2

---



Electrical Composition Corresponding to Codes C9, C11, SF1 and SR1

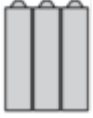

Electrical Composition Corresponding to Code C15

---

1 N/O

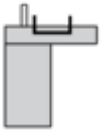

1 N/C



1 N/O + N/C or 1 N/O + N/O or 1 N/C + N/C



**Legend**

---

Single contact



Double contact



Light block



Possible location



Technical Illustration

Dimensions

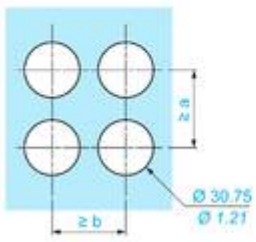
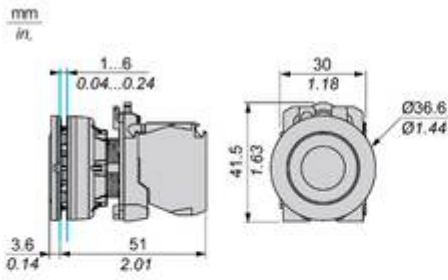

		a (mm)	a (in.)	b (mm)	b (in.)
		40	1.57	40	1.57
ZBE.....	ZBV.....				
		45	1.77	40	1.57
ZBE.....3	ZBV.....3				
		40	1.57	40	1.57
ZBE.....4	ZBV.....4				

Image of product / Alternate images

Alternative

---





Image of product in real life situation

