

# Fișă tehnică produs

Specificatii



## Releu Ambrosabil de Interfata, Zelio Rsb, 1 C/O, 240 V Ca, 12 A

RSB1A120U7

### Principale

gama de produse	Harmony Electromechanical Relays
nume serie	RSB series
Tip produs sau componenta	Releu conectabil
tip releu	Interface relay
tip si compozitie contacte	1 C/O
LED de stare	Fara
tensiune circuit de comanda	240 V c.a. 50/60 Hz
tip de control	Fără buton de test cu blocare
[Ithe] curent termic conventional	12 A la -40...40 °C

### Suplimentare

rezistenta medie	33000 Ohm rețea: c.a. la 20 °C +/- 10 %
[Ue] tensiune nominala	192...360 V c.a. 50/60 Hz
[Uimp] tensiune de tinere la impuls	3,6 kV conformitate cu IEC 61000-4-5
[Ie] curent nominal de utilizare	12 A (AC-1/DC-1) nu conformitate cu IEC 6 A (AC-1/DC-1) NC conformitate cu IEC
[Ui] tensiune nominala de izolatie	400 V conformitate cu SR EN 60947
tensiunea maxima de comutatie	300 V c.c. conformitate cu IEC
prag de tensiune pentru decuplare	>= 0.15 Uc c.a.
curent de sarcina	12 A la 250 V c.a. 12 A la 28 V c.c.
curentul minim comutat	10 mA
capacitate de comutatie maxima	3001 VA/336 W
minimum switching voltage	12 V
capacitate minima de comutatie	120 mW la 10 mA, 12 V
timp de functionare	20 ms funcționare 20 ms resetare
durabilitate mecanica	10000000 cic
durabilitate electrica	100000 cic, 12 A la 250 V, AC-1 nu 100000 cic, 6 A la 250 V, AC-1 NC
fiabilitate securitate date	B10d = 100000
rata de operare	<= 600 cicluri/oră sub sarcină <= 18000 cicluri/oră fara sarcina

consumul mediu in W	0,75 VA c.a.
Removable legend	Fara
categorie de protectie	RT I
pozitie de operare	Orice pozitie
niveluri de testare	Nivel A group mounting
prezentare dispozitiv	Produs complet
cantitate indivizibila de vanzare	10
Material contacte	Aliaj de argint (AgNi)
forma a pinului	Plat (tip PCB)
greutate produs	0,014 kg
Cod compatibilitate	RSB

## Mediu

rigiditate dielectrica	1000 V c.a. între contacte 2500 V c.a. între poli 5000 V c.a. între bobină și contact
rezistenta la vibratii	+/- 1 mm (f= 10...55 Hz) conforming to IEC 60068-2-6
grad de protectie IP	IP40 conforming to SR EN 60529
temperatura ambientala de utilizare	-40...70 °C (c.a.)
standarde	UL 60947-1 CSA C22.2 No 15 IEC 61810-1
certificari produs	CSA UL EAC
marcaj	CE
temperatura ambietala pentru depozitare	-40...85 °C
rezistenta la socuri	10 gn (durata = 11 ms) pentru nu functioneaza conformitate cu IEC 60068-2-27 5 gn (durata = 11 ms) pentru în functionare conformitate cu IEC 60068-2-27

## Unitati de ambalare

Unitate de masura pentru prima forma de impachetare	PCE
Numar unitati in prima forma de impachetare	1
Inaltime prima forma de impachetare	2,2 cm
Latime prima forma de impachetare	2,5 cm
Lungime prima forma de impachetare	31,1 cm
Greutate prima forma de impachetare	15 g
Unitate de masura pentru a doua forma de impachetare	BB1
Numar unitati in a doua forma de impachetare	10
Inaltime a doua forma de impachetare	2,2 cm
Latime a doua forma de impachetare	2,5 cm
Lungime a doua forma de impachetare	31,1 cm
Greutate a doua forma de impachetare	161 g

Unitate de masura pentru a treia forma de impachetare	S01
Numar unitati in a treia forma de impachetare	350
Inaltime a treia forma de impachetare	15 cm
Latime a treia forma de impachetare	15 cm
Lungime a treia forma de impachetare	40 cm
Greutate a treia forma de impachetare	5,84 kg

## Garanție contractuală

Garantie	18 luni
----------	---------

## Environmental Data

Schneider Electric isi propune sa atinga nivelul Net Zero pana in 2050 prin parteneriate la nivelul lantului de aprovizionare, materiale cu impact mai redus si circularitate, prin campania „Use Better, Use Longer, Use Again” pentru a extinde durata de viata a produselor si reciclabilitatea.

[Environmental Data explicate >](#)

[Cum evaluam sustenabilitatea produselor >](#)

### **Amprenta de mediu**

Amprenta de carbon (kg CO2 eq.) 7

Raport de mediu [Profilul ambiental al produsului](#)

### **Use Better**

#### **Materiale si ambalare**

Pachet cu carton reciclabil Da

Ambalaj fara plastic Nu

[Directiva RoHS UE](#) Conformitate proactiva (Produs in afara domeniului de aplicare a EU RoHS)

### **Use Again**

#### **Reambalare si refabricare**

Profil circularitate Nu sunt necesare operatii de reciclare speciale

Preluare la sfarsitul duratei de viata No

DEEE  Produsul trebuie sa fie eliminat de pe piata din Uniunea Europeana dupa colectarea specifica a deseurilor si sa nu ajunga niciodata in pubele de gunoi

Dimensions Drawings

Dimensions

---

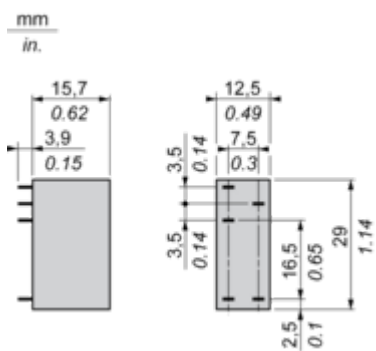

Connections and Schema

Wiring Diagram

---

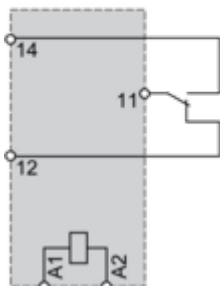
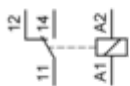

**NOTE:** For DC input, A1 have to be +, otherwise it would short circuit from protection module

Performance Curves

**Electrical Durability of Contacts**

---

**Durability (inductive load) = durability (resistive load) x reduction coefficient.**

Resistive AC load

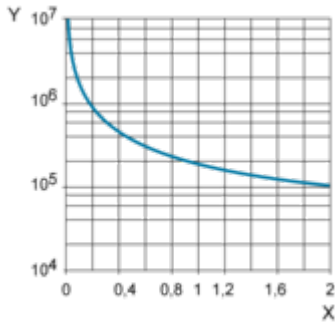

X Switching capacity (kVA)

Y Durability (Number of operating cycles)

Reduction coefficient for inductive AC load (depending on power factor cos φ)

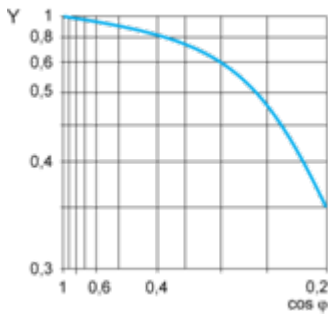

Y Reduction coefficient (A)

Maximum switching capacity on resistive DC load

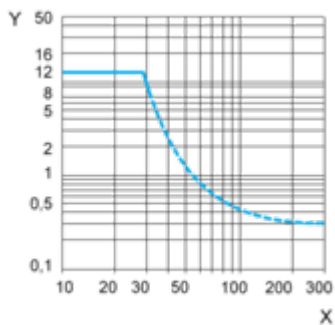

X Voltage DC

Y Current DC

**Note :** These are typical curves, actual durability depends on load, environment, duty cycle, etc.

Technical Illustration

Dimensions

---

mm  
in.

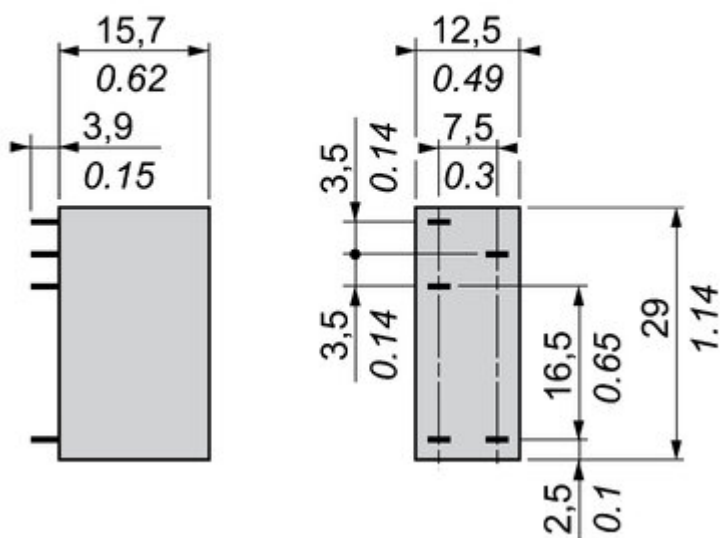
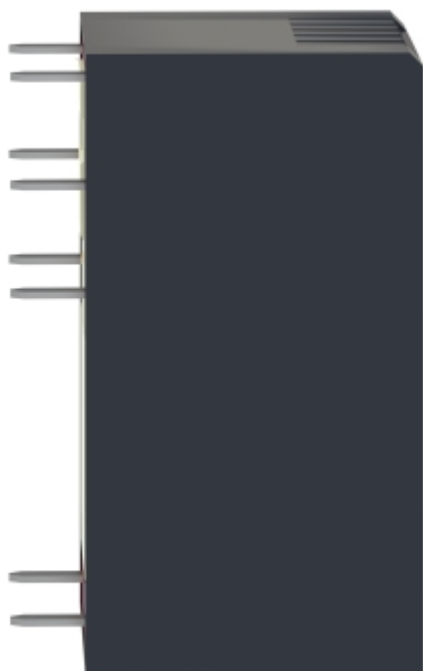

Image of product / Alternate images

Alternative

---



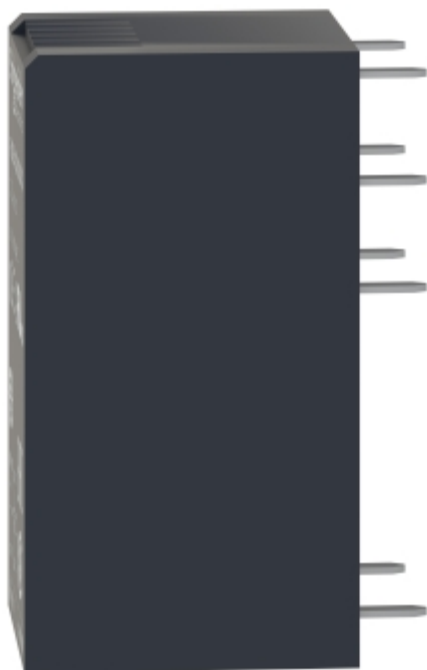
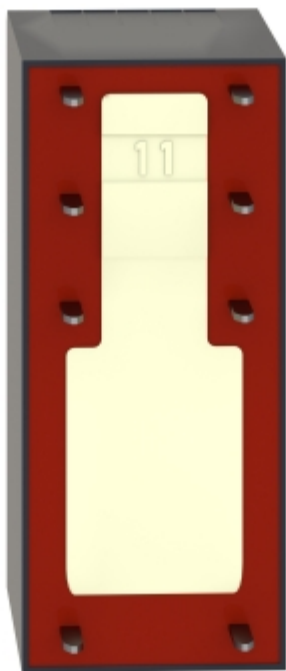

Image of product in real life situation

