

Fișă tehnică produs

Specificatii



Variator de viteza ATV630, 55kW, 75HP, 480-480V, IP21, UL tip 1

ATV630D55N4

Principale

gama de produse	Altivar Process ATV600
aplicatie specifica produsului	Process and utilities
Tip produs sau componenta	Variator de viteza
varianta	Standard version
nume scurt al dispozitivului	ATV630
mod de montare	Wall mount
Port protocol de comunicare	Ethernet Serial Modbus Modbus TCP
[Us] tensiune nominala de alimentare	380...480 V - 15...10 %
[Us] tensiune de alimentare nominala	380...480 V
Relative symmetric mains voltage tolerance	10 %
Relative symmetric network frequency tolerance	5 %
curent nominal de iesire	106,0 A
grad de protectie IP	IP21
destinatia produs	Motoare asincrone Motoare sincrone
filtru EMC	Integrat cu 150 m conformitate cu IEC 61800-3 category C3
grad de protectie IP	IP21 conformitate cu IEC 61800-5-1 IP21 conformitate cu SR EN 60529
grad de protectie	UL tip 1 conformitate cu UL 508C
tip de racire	Convecție forțată
frecventa de alimentare	50...60 Hz - 5...5 %
putere motor kW	55 kW (serviciu normal) 45 kW (pentru sarcini grele)
putere motor hp	75 CP serviciu normal 60 CP pentru sarcini grele
curent de linie	97,2 A la 380 V (serviciu normal) 84,2 A la 480 V (serviciu normal) 81,4 A la 380 V (pentru sarcini grele) 71,8 A la 480 V (pentru sarcini grele)
curent la iesire continuu	106 A la 2,5 kHz pentru serviciu normal 88 A la 2,5 kHz pentru pentru sarcini grele
frecventa de iesire a convertizorului	0,1...500 Hz
functie siguranta	STO (safe torque off) SIL 3

card optional	Slot A modul de comunicare, Profibus DP V1 Slot A modul de comunicare, PROFINET Slot A modul de comunicare, DeviceNet Slot A modul de comunicare, Modbus TCP/EtherNet/IP Slot A modul de comunicare, rețea CANopen RJ45 Slot A modul de comunicare, CANopen SUB-D 9 Slot A modul de comunicare, CANopen screw terminals Slot A/slot B digital and analog I/O extension module Slot A/slot B output relay extension module Slot A modul de comunicare, Ethernet IP/Modbus TCP/MD-Link modul de comunicare, BACnet MS/TP modul de comunicare, Ethernet Powerlink
----------------------	---

Suplimentare

numar intrare discreta	8
tip de intrare discreta	DI7, DI8 programmable as pulse input 0...30 kHz, 24 V c.c. (<= 30 V)
logica de intrare discreta	16 preset speeds
numar iesire discreta	0
tip de iesire discreta	leșiri releu R1A, R1B, R1C 250 V c.a. 3000 mA leșiri releu R1A, R1B, R1C 30 V c.c. 3000 mA leșiri releu R2A, R2C 250 V c.a. 5000 mA leșiri releu R2A, R2C 30 V c.c. 5000 mA leșiri releu R3A, R3C 250 V c.a. 5000 mA leșiri releu R3A, R3C 30 V c.c. 5000 mA
numarul intrarii analogice	3
tip de intrare analogica	AI1, AI2, AI3 tensiune configurabilă soft 0...10 V c.c., impedanță: 31.5 kOhm, rezoluție 12 biti AI1, AI2, AI3 curent configurabil soft 0...20 mA, impedanță: 250 Ohm, rezoluție 12 biti AI2 tensiune de intrare analogica - 10...10 V c.c., impedanță: 31.5 kOhm, rezoluție 12 biti
numarul iesirii analogice	2
tip iesire analogica	Tensiune configurabilă soft AQ1, AQ2 0...10 V c.c. 470 Ohm, rezoluție 10 bits Curent configurabil soft AQ1, AQ2 0...20 mA, rezoluție 10 bits Curent configurabil soft DQ-, DQ+ 30 V c.c. Curent configurabil soft DQ-, DQ+ 100 mA
numarul iesirii releu	3
tip releu iesire	Configurable relay logic R1 releu de defect NO/NC 100000 cic Configurable relay logic R2 sequence relay nu 100000 cic Configurable relay logic R3 sequence relay nu 100000 cic
curent maxim de comutatie	Relay output R1, R2, R3 pornit rezistiv sarcina, cos phi = 1 3 A la 250 V c.a. Relay output R1, R2, R3 pornit rezistiv sarcina, cos phi = 1 3 A la 30 V c.c. Relay output R1, R2, R3 pornit inductiv sarcina, cos phi = 0,4 si stanga/dreapta = 7 ms 2 A la 250 V c.a. Relay output R1, R2, R3 pornit inductiv sarcina, cos phi = 0,4 si stanga/dreapta = 7 ms 2 A la 30 V c.c.
curentul minim de comutare	Relay output R1, R2, R3 5 mA la 24 V c.c.
numar faze in retea	3 faze
interfata fizica	Ethernet RS 485 cu 2 fire
metoda de acces	Slave Modbus TCP
rata de transmisie	10, 100 Mbits 4800 bps, 9600 bps, 19200 bps, 38.4 Kbps
cadrul de transmisie	RTU
tensiune de iesire	<= tensiunea de alimentare
crestere temporara admisibila a curentului	1.1 x In in timpul 60 s (serviciu normal) 1.5 x In in timpul 60 s (pentru sarcini grele)
format date	8 biti, configurabil impar, par sau fara paritate

tip de polarizare	Fara impedanta
rezolutia frecventei	Unitate de afisare 0.1 Hz Intrare analogică 0.012/50 Hz
conexiune electrica	Control borne debrășabile 0.5...1.5 mm ² AWG 20...AWG 16 Line side borna cu surub 70...120 mm ² AWG 1/0...250 kcmil Motor borna cu surub 70...120 mm ² AWG 1/0...250 kcmil
tipul conectorului	RJ45 (on the remote graphic terminal) pentru Ethernet/Modbus TCP RJ45 (on the remote graphic terminal) pentru serial Modbus
mod de schimb	Half duplex, full duplex, autonegociere Ethernet/Modbus TCP
numar de adrese	1...247 pentru serial Modbus
alimentare	External supply for digital inputs 24 V c.c. (19...30 V), <1,25 mA, tip de protecție: protecție la suprasarcina si scurtcircuit Sursă internă pentru potențiometrul de referință (1 la 10 kOhm) 10.5 V c.c. +/- 5 %, <10 mA, tip de protecție: protecție la suprasarcina si scurtcircuit Internal supply for digital inputs and STO 24 V c.c. (21...27 V), <200 mA, tip de protecție: protecție la suprasarcina si scurtcircuit
semnalizare locala	3 LEDs for local diagnostic 3 LEDs (dual colour) for embedded communication status 4 LEDs (dual colour) for communication module status 1 LED (rosu) for prezenta tensiune
compatibilitate intrare	DI1...DI6 intrare directă nivel 1 PLC conformitate cu IEC 61131-2 DI5, DI6 intrare directă nivel 1 PLC conformitate cu IEC 65A-68 STOA, STOB intrare directă nivel 1 PLC conformitate cu IEC 61131-2
logica de intrare discreta	Logica pozitiva (sursa) (DI1...DI8), < 5 V (stare 0), > 11 V (stare 1) Logica negativa (derivatie) (DI1...DI8), > 16 V (stare 0), < 10 V (stare 1)
perioada de esantionare	2 ms +/- 0.5 ms (DI1...DI4) - intrare directă 5 ms +/- 1 ms (DI5, DI6) - intrare directă 5 ms +/- 0.1 ms (AI1, AI2, AI3) - intrare analogică 10 ms +/- 1 ms (AO1) - ieșire analogică
precizie	+/- 0.6 % AI1, AI2, AI3 pentru o variație a temperaturii 60 °C intrare analogică +/- 1 % AO1, AO2 pentru o variație a temperaturii 60 °C ieșire analogică
eroare de liniaritate	AI1, AI2, AI3 +/- 0.15 % din valoarea maximă pentru intrare analogică AO1, AO2 +/- 0.2 % pentru iesire analogica
țimp de reimprospatare	Relay output (R1, R2, R3)5 ms (+/- 0.5 ms)
izolatie	Intre alimentare si bornele de control
proces fabricatie	Building - HVAC compressor centrifugal Food and beverage processing other application Mining mineral and metal fan Mining mineral and metal pump Oil and gas fan Water and waste water other application Building - HVAC screw compressor Food and beverage processing pump Food and beverage processing fan Food and beverage processing atomization Oil and gas electro submersible pump (ESP) Oil and gas water injection pump Oil and gas jet fuel pump Oil and gas compressor for refinery Water and waste water centrifuge pump Water and waste water positive displacement pump Water and waste water electro submersible pump (ESP) Water and waste water screw pump Water and waste water lobe compressor Water and waste water screw compressor Water and waste water compressor centrifugal Water and waste water fan Water and waste water conveyor Water and waste water mixer
interval putere	55...100 kW la 380...440 V 3 faze 55...100 kW la 480...500 V 3 faze
montare dulap	Montaj pe perete

4 quadrant operation possible	Fals
profil de control al motorului asincron	Constanta de cuplu standard Cuplu variabil standard Mod de cuplu optim
profil de control al motorului sincron	Permanent magnet motor Synchronous reluctance motor
frecventa maxima de iesire	500 kHz
rampe de accelerare si decelerare	Reglabil liniar separat, de la 0,01 la 9999 s
compensare alunecare motor	Not available in permanent magnet motor law Poate fi suprimat Automat indiferent de sarcina Reglabil
frecventa de comutare	2.5...8 kHz cu 2...8 kHz reglabil
frecventa de comutare nominala	2,5 kHz
franare sau imobil	Cu injectie c.c.
Brake chopper integrated	Fals
Curent maxim de intrare	97,2 A
Maximum output voltage	480,0 V
putere aparenta	70 kVA la 480 V (serviciu normal) 59,7 kVA la 480 V (pentru sarcini grele)
curent tranzitoriu maxim	116,6 A in timpul 60 s (serviciu normal) 132 A in timpul 60 s (pentru sarcini grele)
frecventa retea electrica	50...60 Hz
curent de scurtcircuit prezumat I_{sc}	50 kA
Base load current at high overload	88,0 A
Base load current at low overload	106,0 A
puterea disipata in W	Convecție naturala 131 W la 380 V 2,5 kHz Convecție fortata 917 W la 380 V 2,5 kHz
cu functia de siguranta Safely Limited Speed (SLS)	Fals
cu functia de siguranta Safe brake management (SBC/SBT)	Fals
cu functia de siguranta Safe Operating Stop (SOS)	Fals
cu functia de siguranta Safe Position (SP)	Fals
cu functia de siguranta Safe programmable logic	Fals
cu functia de siguranta Safe Speed Monitor (SSM)	Fals
cu functia de siguranta Safe Stop 1 (SS1)	Fals
cu functia de siguranta Safe Stop 2 (SS2)	Fals
cu functia de siguranta Safe torque off (STO)	Adevarat
cu functia de siguranta Safely Limited Position (SLP)	Fals
cu functia de siguranta Safe Direction (SDI)	Fals

tip de protectie	Protectie termica motor Safe torque off motor Întrerupere fază motor motor Protectie termica variator Safe torque off variator Supraincalzire variator Supracurent între fazele de ieşire și pământ variator Overload of output voltage variator Protectie la scurtcircuit variator Întrerupere fază motor variator Supratensiuni pe magistrala de c.c. variator Supratensiune în linia de alimentare variator Scăderea tensiunii de alimentare variator Pierdere de fază în alimentarea liniei de alimentare variator Overspeed variator Defectarea circuitului de comandă variator
Cantitate pe set	1
latime	290 mm
inaltime	922 mm
adancime	323 mm
greutate produs	56,5 kg

Mediu

rezistenta de izolatie	> 1 MOhm 500 V c.c. pentru 1 minut la pământ
nivel de zgomot	62,4 dB conformitate cu 86/188/EEC
grad de poluare	2 conformitate cu IEC 61800-5-1
rezistenta la vibratii	1.5 mm vârf la vârf (f= 2...13 Hz) conforming to IEC 60068-2-6 1 gn (f= 13...200 Hz) conforming to IEC 60068-2-6
rezistenta la socuri	15 gn pentru 11 ms conformitate cu IEC 60068-2-27
umiditate relativa	5...95 % fără condensare conformitate cu IEC 60068-2-3
temperatura ambientala de utilizare	-15...50 °C (fără declasare) 50...60 °C (cu)
altitudinea de functionare	<= 1000 m fără declasare 1000...4800 m cu declasarea curentului cu 1 % pe 100 m
pozitie de operare	Vertical +/- 10 grade
certificari produs	CSA UL DNV-GL ATEX INERIS ATEX zona 2/22 TÜV
marcaj	CE
standarde	UL 508C IEC 61800-3 IEC 61800-3 environment 1 category C2 EN/IEC 61800-3 environment 2 category C3 IEC 61800-5-1 IEC 61000-3-12 IEC 60721-3 IEC 61508 IEC 13849-1
THDI maxim	<48 % from 80...100 % of load conformitate cu IEC 61000-3-12
compatibilitate electromagnetica	Test de imunitate la descarcari electrostatice nivel 3 conforming to IEC 61000-4-2 Test de imunitate la frecventa radio radiata nivel 3 conforming to IEC 61000-4-3 Tranzienți rapizi/test de imunitate la impulsuri de ionizare nivel 4 conforming to IEC 61000-4-4 1.2/50 µs - 8/20 µs test de imunitate la supratensiuni nivel 3 conforming to IEC 61000-4-5 Test de imunitate la radiofrecvență condusă nivel 3 conforming to IEC 61000-4-6

clasa de mediu (in timpul functionarii)	Clasa 3C3 in conformitate cu IEC 60721-3-3-3 Class 3S3 according to IEC 60721-3-3
acceleratia maxima in cazul unui impact de soc (in timpul functionarii)	150 m/s ² la 11 ms
acceleratia maxima sub tensiune de vibratie (in timpul functionarii)	10 m/s ² la 13...200 Hz
deformarea maxima sub sarcina vibratorie (in timpul functionarii)	1.5 mm la 2...13 Hz
Permitted relative humidity (during operation)	Class 3K5 according to EN 60721-3
volumul aerului de racire	295 m ³ /h
categorie de supratensiune	III
bucla de reglare	Regulator PID reglabil
nivel de zgomot	62,4 dB
Grad de poluare	2
Temperatura de transport a aerului ambiental	-40...70 °C
temperatura ambietala pentru depozitare	-40...70 °C

Unitati de ambalare

Unitate de masura pentru prima forma de impachetare	PCE
Numar unitati in prima forma de impachetare	1
Inaltime prima forma de impachetare	47,0 cm
Latime prima forma de impachetare	43,0 cm
Lungime prima forma de impachetare	110,0 cm
Greutate prima forma de impachetare	64,0 kg

Garanție contractuală

Garantie	18 luni
----------	---------

Environmental Data

Schneider Electric isi propune sa atinga nivelul Net Zero pana in 2050 prin parteneriate la nivelul lantului de aprovizionare, materiale cu impact mai redus si circularitate, prin campania „Use Better, Use Longer, Use Again” pentru a extinde durata de viata a produselor si reciclabilitatea.

[Environmental Data explicate >](#)

[Cum evaluam sustenabilitatea produselor >](#)

Amprenta de mediu

Amprenta de carbon (kg CO2 eq.) 37537

Raport de mediu [Profilul ambiental al produsului](#)

Use Better

Materiale si ambalare

Pachet cu carton reciclabil Da

Ambalaj fara plastic Nu

[Directiva RoHS UE](#) Conformitate proactiva (Produs in afara domeniului de aplicare a EU RoHS)

Numar SCIP B8d5fdde-166b-4332-b5d0-afde1be95439

Regulamentul REACH [Declaratia REACH](#)

Eficienta energetica

Contributiia produs a fost evitata Yes

Use Again

Reambalare si refabricare

Profil circularitate [Informatii privind sfarsitul duratei de viata](#)

Preluare la sfarsitul duratei de viata No

DEEE  Produsul trebuie sa fie eliminat de pe piata din Uniunea Europeana dupa colectarea specifica a deseurilor si sa nu ajunga niciodata in pubele de gunoi

Dimensions Drawings

Dimensions

Drives with IP21 Top Cover

Front and Left Views

mm
in.

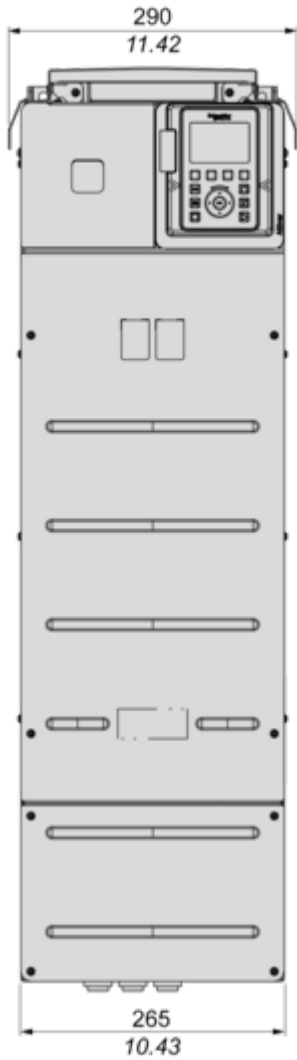

mm
in.



Drives Without IP21 Top Cover

Left and Rear Views

mm
in.

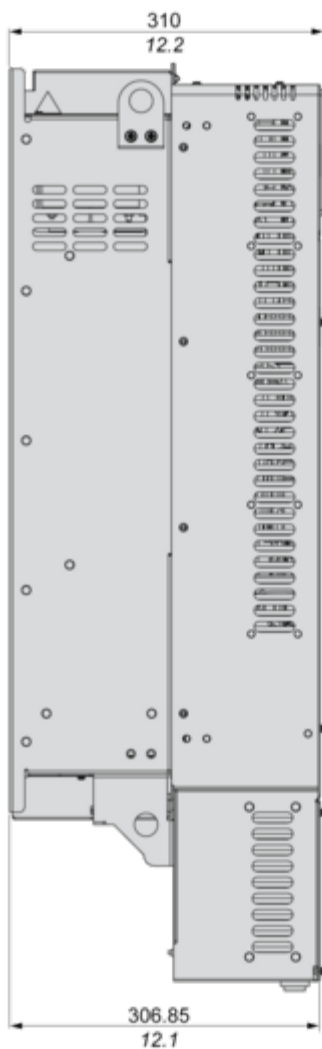

mm
in.

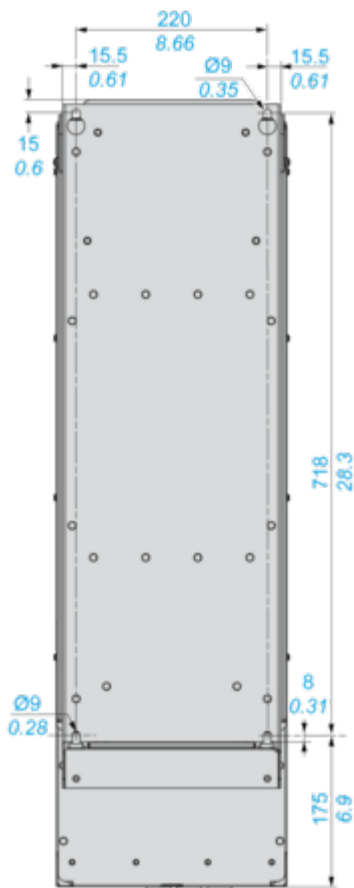

Mounting and Clearance

Clearances

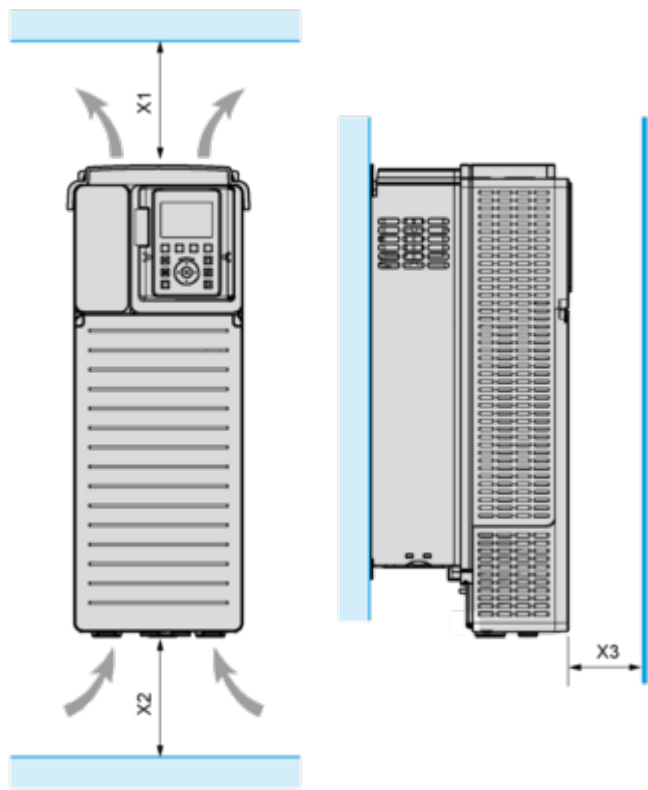

X1	X2	X3
≥ 100 mm (3.94 in.)	≥ 100 mm (3.94 in.)	≥ 10 mm (0.39 in.)

Mounting Types

Mounting Type A: Individual IP21



$a \geq 110 \text{ mm (4.33 in.)}$

Mounting Type B: Side by Side IP20 (Possible, 2 Drives Only)

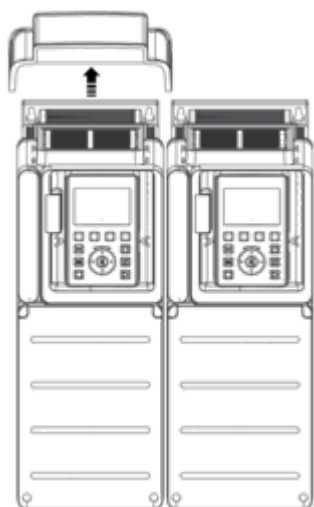

Mounting Type C: Individual IP20



$a \geq 110 \text{ mm (4.33 in.)}$

Connections and Schema

Three-Phase Power Supply with Upstream Breaking via Line Contactor

Connection diagrams conforming to standards EN 954-1 category 1 and IEC/EN 61508 capacity SIL1, stopping category 0 in accordance with standard IEC/EN 60204-1

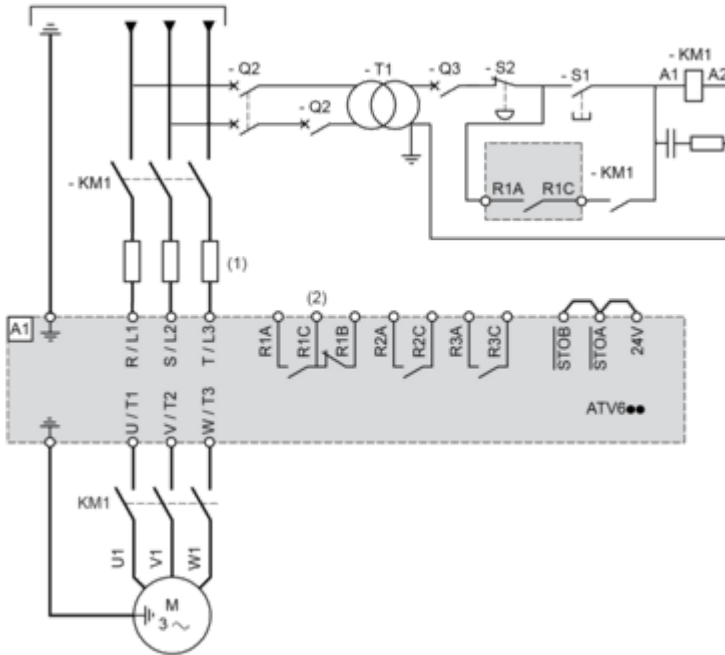

(1) Line choke if used

(2) Use relay R1 set to operating state Fault to switch Off the product once an error is detected.

A1 : Drive

KM1 : Line Contactor

Q2, Q3 : Circuit breakers

S1, S2 : Pushbuttons

T1 : Transformer for control part

Three-Phase Power Supply with Downstream Breaking via Contactor

Connection diagrams conforming to standards EN 954-1 category 1 and IEC/EN 61508 capacity SIL1, stopping category 0 in accordance with standard IEC/EN 60204-1

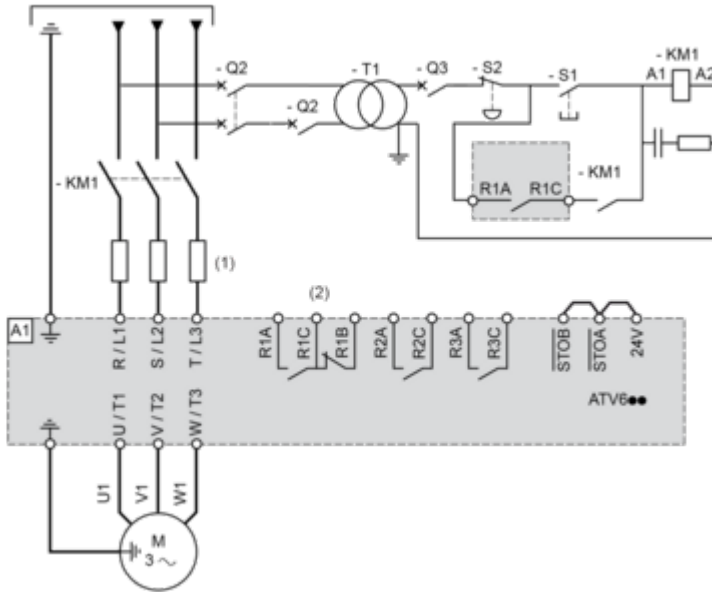

(1) Line choke if used

(2) Use relay R1 set to operating state Fault to switch Off the product once an error is detected.

A1 : Drive

KM1 : Contactor

Control Block Wiring Diagram

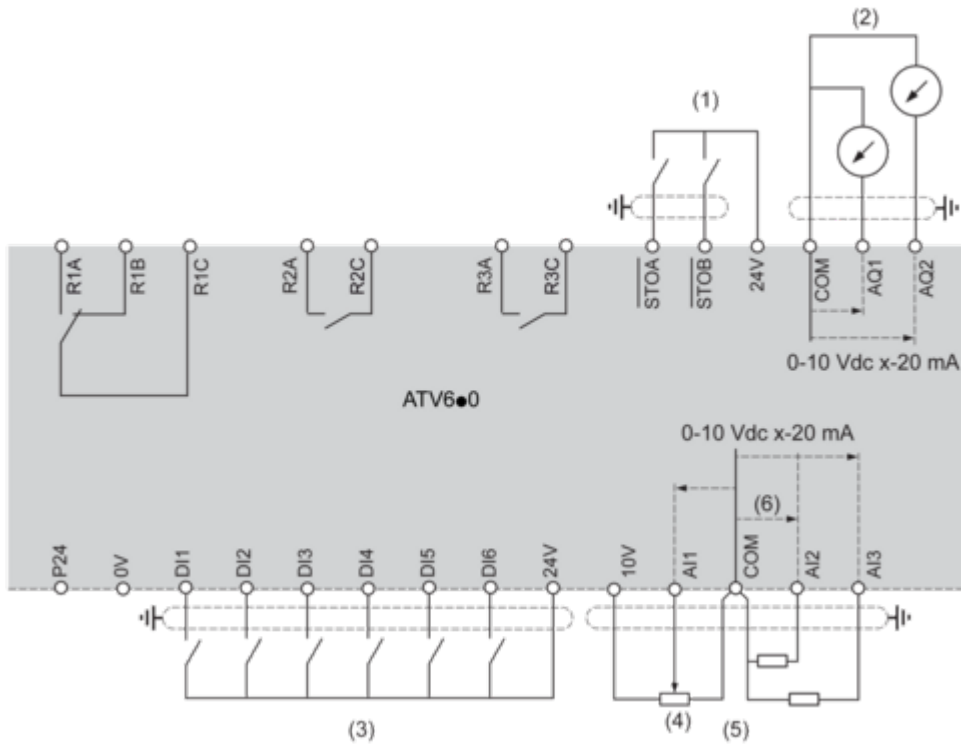

- (1) Safe Torque Off
- (2) Analog Output
- (3) Digital Input
- (4) Reference potentiometer
- (5) Analog Input
- R1A, R1B, R1C : Fault relay
- R2A, R2C : Sequence relay
- R3A, R3C : Sequence relay

Sensor Connection

It is possible to connect either 1 or 3 sensors on terminals AI2 or AI3.



Sink / Source Switch Configuration

The switch is used to adapt the operation of the logic inputs to the technology of the programmable controller outputs.

- Set the switch to Source (factory setting) if using PLC outputs with PNP transistors.
- Set the switch to Ext if using PLC outputs with NPN transistors.

Switch Set to SRC (Source) Position Using the Output Power Supply for the Digital Inputs

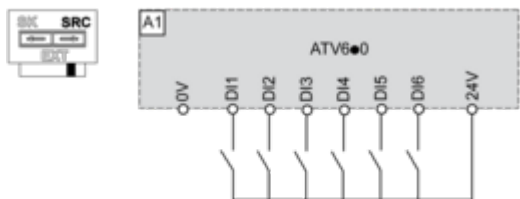

Switch Set to SRC (Source) Position and Use of an External Power Supply for the DIs

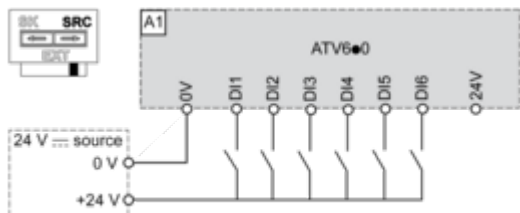

Switch Set to SK (Sink) Position Using the Output Power Supply for the Digital Inputs

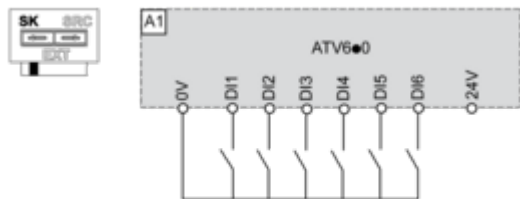

Switch Set to EXT Position Using an External Power Supply for the DIs

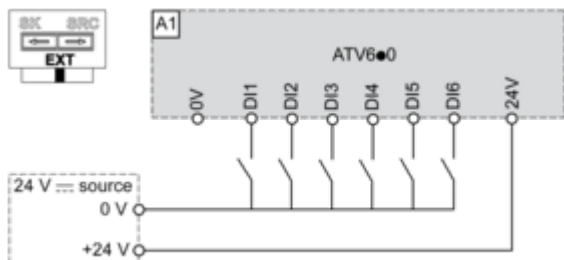

Performance Curves

Derating Curves

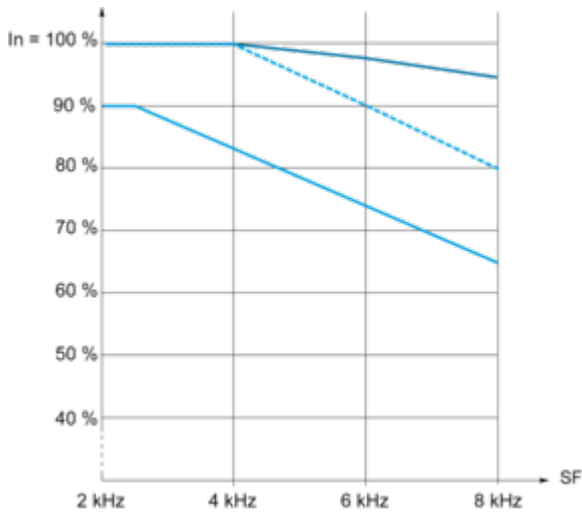

— 40 °C (104 °F) - Mounting type A, B and C

⋯ 50 °C (122 °F) - Mounting type A, B and C

— 60 °C (140 °F) - Mounting type B and C

In : Nominal Drive Current

SF : Switching Frequency

Image of product / Alternate images

Alternative





