



SENTRON 3LD5 switch disconnecter UL, EMERGENCY-OFF switch, 3-pole, approved according to UL 489, UL 60947-4-1 and IEC 60947-3, UL: 100 A, SCCR 65 kA at 480 V AC, operational power @ 480 V AC 3-phase: 60 hp, IEC: 100 A, operational power at AC-23 A at 400 V: 45 kW, floor mounting with direct operating mechanism, red/yellow including terminal covers for the infeed side

Model	
product brand name	SENTRON
product designation	Switch disconnecter
design of the product	EMERGENCY-STOP switch
display version for switch position indicator manual operation	1 ON - 0 OFF
type of switch	Floor mounting with direct drive
design of the actuating element	selector switch
color of the actuating element	red
design of handle	knob-operated mechanism, red/yellow
type of the driving mechanism motor drive	No
General technical data	
number of poles	3
size of switch disconnecter	3
mechanical service life (operating cycles) typical	100 000
electrical endurance (operating cycles)	
• at AC-23 A at 690 V	6 000
operating frequency maximum	50 1/h
degree of pollution	3
Voltage	
insulation voltage rated value	690 V
surge voltage resistance rated value	6 kV
operating voltage	
• at AC rated value	690 V
operating frequency rated value	
• minimum	50 Hz
• maximum	60 Hz
Protection class	
protection class IP	IP00
protection class IP on the front	IP00
Dissipation	
power loss [W] for rated value of the current at AC in hot operating state per pole	36 W
Main circuit	
operational current	
• at AC-21 at 690 V rated value	100 A
• at AC-21 A at 240 V rated value	100 A
• at AC-21 A at 400 V rated value	100 A
• at AC-21 A at 440 V rated value	100 A

<ul style="list-style-type: none"> at AC-23 A at 400 V rated value 	100 A
operating power	
<ul style="list-style-type: none"> at AC-23 A at 240 V rated value 	30 kW
<ul style="list-style-type: none"> at AC-23 A at 440 V rated value 	45 kW
<ul style="list-style-type: none"> at AC-23 A at 690 V rated value 	37 kW
<ul style="list-style-type: none"> at AC-3 at 240 V rated value 	30 kW
<ul style="list-style-type: none"> at AC-3 at 400 V rated value 	45 kW
<ul style="list-style-type: none"> at AC-3 at 690 V rated value 	30 kW
Auxiliary circuit	
number of CO contacts for auxiliary contacts	0
number of NC contacts for auxiliary contacts	0
number of NO contacts for auxiliary contacts	0
operating voltage of auxiliary contacts at AC maximum	500 V
continuous current of the auxiliary contact rated value	10 A
insulation voltage of the auxiliary switch rated value	500 V
Suitability	
suitability for use main switch	Yes
suitability for use switch disconnecter	Yes
suitability for use EMERGENCY OFF switch	Yes
suitability for use safety switch	Yes
suitability for use maintenance/repair switch	Yes
Product details	
product feature can be locked into OFF position	Yes
Accessories	
product extension optional	
<ul style="list-style-type: none"> motor drive 	No
<ul style="list-style-type: none"> voltage trigger 	No
number of connectable NC contacts for auxiliary contacts attachable maximum	2
number of connectable NO contacts for auxiliary contacts attachable maximum	4
number of connectable CO contacts for auxiliary contacts attachable maximum	0
number of bracket locks maximum	3
hasp thickness of the bracket locks	5 ... 7.5 mm
Short circuit	
conditional short-circuit current with line-side fuse protection	
<ul style="list-style-type: none"> at 440 V by gG fuse rated value 	50 kA
<ul style="list-style-type: none"> at 690 V by gG fuse rated value 	50 kA
let-through current with closed switch	
<ul style="list-style-type: none"> at 240 V for combination switch + gG fuse maximum 	16 kA
<ul style="list-style-type: none"> at 440 V for combination switch + gG fuse maximum 	16 kA
<ul style="list-style-type: none"> at 690 V for combination switch + gG fuse maximum permissible 	15 kA
I²t value with closed switch	
<ul style="list-style-type: none"> at 240 V for combination switch + gG fuse maximum 	223 kA ² ·s
<ul style="list-style-type: none"> at 440 V for combination switch + gG fuse maximum 	223 kA ² ·s
<ul style="list-style-type: none"> at 690 V for combination switch + gG fuse maximum 	223 kA ² ·s
design of the fuse link	
<ul style="list-style-type: none"> for short-circuit protection of the main circuit required 	Fuse gG: 125 A
<ul style="list-style-type: none"> for short-circuit protection of the auxiliary switch required 	fuse gL/gG: 10 A
operational current of upstream fuse rated value	125 A
according UL	
operational current at AC according to UL 489/UL 60947-4-1 rated value	100 A
operational current at AC according to UL 508/UL 60947-4-1 rated value	100 A
operating voltage at AC at 50/60 Hz according to UL 489 rated value	480 V
operating voltage at AC at 50/60 Hz according to UL 508/UL	480 V

60947-4-1 rated value	
active power [hp] at AC at 480 V according to UL 508/UL 60947-4-1 rated value	60
short-time withstand current (SCCR) at 480 V according to UL 508/UL 60947-4-1 and UL 489	65 kA
continuous current of upstream fuse according to UL rated value	100 A
type of fuse according to UL	Class J

Connections

AWG number as coded connectable conductor cross section solid maximum	
•	3
•	4/0
AWG number as coded connectable conductor cross section solid according to UL 489	
• minimum	3
• maximum	4/0
AWG number as coded connectable conductor cross section solid according to CSA C22.2 No. 5-16	
• minimum	3
• maximum	2/0
type of connectable conductor cross-sections for copper conductor	
• solid	1x (16 ...185mm ²)
• finely stranded with core end processing	1x (16...150mm ²)
• stranded	1x (16...185mm ²)
type of connectable conductor cross-sections for auxiliary contacts	
• solid	2x (0.75 ... 2.5 mm ²), 1x 4 mm ²
• finely stranded with core end processing	2x (0.75 ... 1.5 mm ²), 1x 2.5 mm ²
• stranded	2x (0.75 ... 2.5 mm ²), 1x 4 mm ²
type of electrical connection	
• for main current circuit	box terminal
• for auxiliary contacts	connection terminals

Mechanical Design

height	178 mm
width	113 mm
depth	158 mm
type of device	fixed mounting
fastening method	Built-in unit fixed-mounted version
fastening method	
• 4-hole front mounting	No
• front mounting with central attachment	No
• rail mounting	No
Net Weight	2.07 kg

Environmental conditions

ambient temperature during operation	
• minimum	-25 °C
• maximum	55 °C
ambient temperature during storage	
• minimum	-25 °C
• maximum	55 °C

Approvals Certificates

Environment	General Product Approval
--------------------	--------------------------

[Environmental Con-
firmations](#)



Further information

Information on the packaging

<https://support.industry.siemens.com/cs/ww/en/view/109813875>

Information for data generation and storage

<https://support.industry.siemens.com/cs/ww/en/view/109995012>

Information- and Downloadcenter (Catalogs, Brochures,...)

<https://www.siemens.com/lowvoltage/catalogs>

Industry Mall (Online ordering system)

<https://mall.industry.siemens.com/mall/en/en/Catalog/product?mlfb=3LD5400-0TK13>

Service&Support (Manuals, Certificates, Characteristics, FAQs,...)

<https://support.industry.siemens.com/cs/ww/en/ps/3LD5400-0TK13>

Image database (product images, 2D dimension drawings, 3D models, device circuit diagrams, ...)

https://www.automation.siemens.com/bilddb/cax_en.aspx?mlfb=3LD5400-0TK13

CAX-Online-Generator

<https://www.siemens.com/cax>

Tender specifications

<https://www.siemens.com/specifications>

Characteristic curves

[https://curves.simaris.siemens.com/curves/<mmp_prod_noCOMP="HAUPT"></mmp_prod_no>](https://curves.simaris.siemens.com/curves/<mmp_prod_noCOMP=)

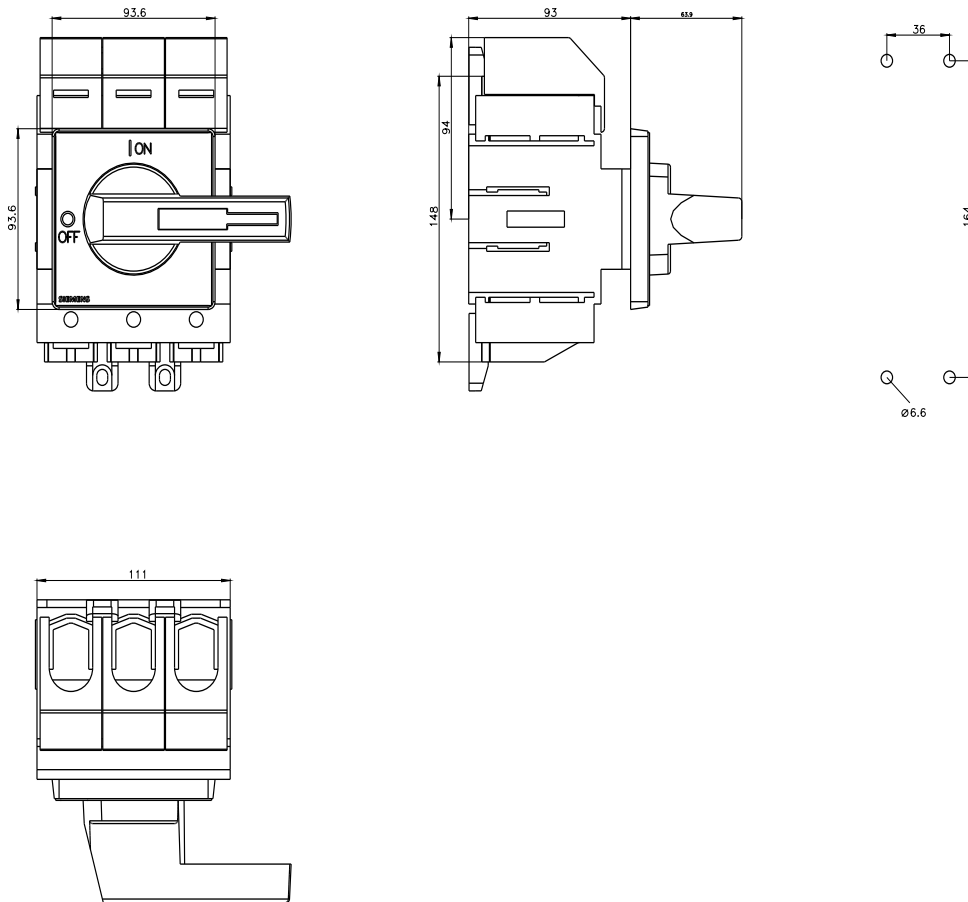

last modified:

10/14/2025

