

Pin busbar, 10 mm² connection: 2x (2-phase+AUX/FS) touch-safe

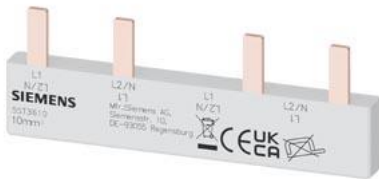

Figure similar

product brand name	SENTRON
product designation	Pin busbar
design of the product	2x (1PH+N+HS)
design of the phase tap	L1/L2 oder L1/N
General technical data	
compatibility	for 2 MCBs (2P/1P+N)
design of pole	2P / 1P+N
phase number	2
operational current rated value	63 A
suitability for interaction devices with auxiliary switch	Yes
suitability for interaction devices with N conductor	Yes
suitability for use	RCCB 2P N right
color	light grey
Product details	
product feature attachable arc fault detection device	No
product feature insulated	Yes
product function	
• suitable for compact devices	No
• can be cut	No
number of devices suitable for fitting	2
type of electrical connection	Pin
Mechanical Design	
module width	18 mm
height	19 mm
width	7 mm
length	76 mm
number of modular width units	4
cross-section	10 mm ²
angle of the pin of busbar	0°
Net Weight	20 g
Approvals Certificates	
Environment	General Product Approval

[Environmental Con-
firmations](#)

[Environmental Con-
firmations](#)

[Miscellaneous](#)



Further information

Information on the packaging

<https://support.industry.siemens.com/cs/ww/en/view/109813875>

Information for data generation and storage

<https://support.industry.siemens.com/cs/ww/en/view/109995012>

Information- and Downloadcenter (Catalogs, Brochures,...)

<https://www.siemens.com/lowvoltage/catalogs>

Industry Mall (Online ordering system)

<https://mall.industry.siemens.com/mall/en/en/Catalog/product?mlfb=5ST3610>

Service&Support (Manuals, Certificates, Characteristics, FAQs,...)

<https://support.industry.siemens.com/cs/ww/en/ps/5ST3610>

Image database (product images, 2D dimension drawings, 3D models, device circuit diagrams, ...)

https://www.automation.siemens.com/bilddb/cax_en.aspx?mlfb=5ST3610

CAX-Online-Generator

<https://www.siemens.com/cax>

Tender specifications

<https://www.siemens.com/specifications>

Characteristic curves

[https://curves.simaris.siemens.com/curves/<mmp_prod_noCOMP="HAUPT"></mmp_prod_no>](https://curves.simaris.siemens.com/curves/<mmp_prod_noCOMP=)

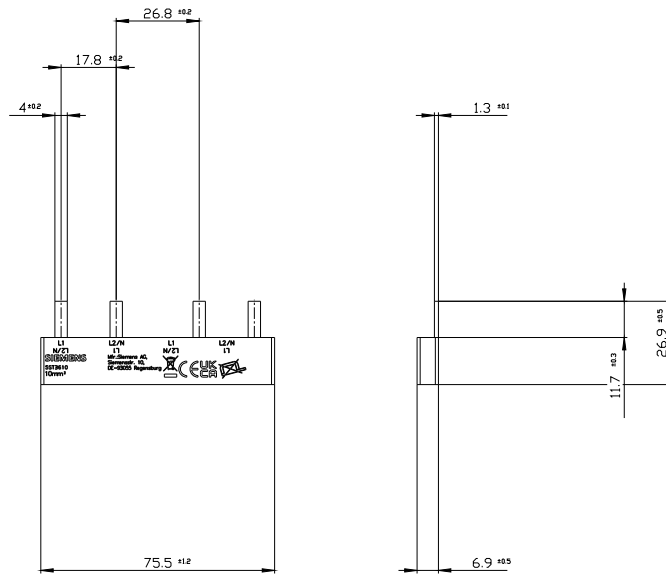

last modified:

1/15/2026

