

Fișă tehnică produs

Specificatii



Post De Comanda Gol - Xal-K - Plastic - 1 Deschidere

XALK01

Principale

gama de produse	Harmony XALK
Tip produs sau componenta	Post de comanda gol
nume scurt al dispozitivului	XALK
destinatie produs	Pentru unitati de comanda si semnalizare XB5 Ø 22 mm
aplicatie post de comanda	Funcție de oprire de urgenta Funcție de oprire de urgenta
Numar de decupari	1 decupaj
culoarea bazei carcasi	Gri deschis (RAL 7035)
culoare a capacului	Galben (RAL 1021)
material	Policarbonat
intrare pentru cablu	1 perforație pentru o intrare de cablu, capacitate de prindere: 14 mm 2 găuri predefinite pentru presetupe Pg 13 și ISO M20, capacitate de prindere: 12 mm
grad de protectie IP	IP66 conformitate cu SR EN 60529 IP67 IP69 IP69K

Suplimentare

stil de asamblare	Pentru ansamblu client
numar de randuri orizontale	1
numar de coloane	1
greutate produs	0,136 kg
rezistenta la spalare cu presiune inalta	7000000 Pa la 55 °C, distanta : 0.1 m
montarea cutiei de borne	Montajin fata Montaj spate
codul compozitiei electrice	SR1 SF1 MR1 MF1
grup principal	1 cut-out
grup de produse	Standard yellow

Mediu

tratament protector	TH
temperatura ambietala pentru depozitare	-40...70 °C

temperatura ambientală de funcționare	-40...70 °C
categorie de supratensiune	Clasa II conforming to IEC 60536
grad de protecție NEMA	NEMA 13 NEMA 4X
grad de protecție IK	IK03 conformitate cu IEC 62262
standarde	IEC 60947-5-5 UL 60947-1 SR EN 60947-5-4 JIS C8201-5-1 CSA C22.2 No 15 IEC 60947-1 SR EN 60947-5-1 JIS C8201-1

Unitati de ambalare

Unitate de masura pentru prima forma de impachetare	PCE
Număr de produse în pachet	1
Înălțime prima forma de impachetare	6,800 cm
Latime prima forma de impachetare	7,500 cm
Lungime prima forma de impachetare	6,800 cm
Greutate colet(Lbs)	114,000 g
Unitate de masura pentru a doua forma de impachetare	S03
Numar unitati in a doua forma de impachetare	60
Înălțime a doua forma de impachetare	30,000 cm
Latime a doua forma de impachetare	30,000 cm
Lungime a doua forma de impachetare	40,000 cm
Greutate a doua forma de impachetare	7,308 kg
Unitate de masura pentru a treia forma de impachetare	P06
Numar unitati in a treia forma de impachetare	480
Înălțime a treia forma de impachetare	75,000 cm
Latime a treia forma de impachetare	60,000 cm
Lungime a treia forma de impachetare	80,000 cm
Greutate a treia forma de impachetare	73,724 kg

Garanție contractuală

Garantie (in luni)	18
--------------------	----

Schneider Electric isi propune sa atinga nivelul Net Zero pana in 2050 prin parteneriate la nivelul lantului de aprovizionare, materiale cu impact mai redus si circularitate, prin campania „Use Better, Use Longer, Use Again” pentru a extinde durata de viata a produselor si reciclabilitatea.

[Environmental Data explicate >](#)

[Cum evaluam sustenabilitatea produselor >](#)

Amprenta de mediu

Amprenta de carbon totala pe durata de viata	0.9 kg CO2 eq.
Amprenta de carbon a fazei de fabricație [A1–A3]	0.9 kg CO2 eq.
Amprenta de carbon a fazei de distribuție [A4]	0 kg CO2 eq.
Amprenta de carbon a fazei de instalare [A5]	0 kg CO2 eq.
Amprenta de carbon a fazei de utilizare [B2, B3, B4, B6]	0 kg CO2 eq.
Amprenta de carbon a fazei de sfârșit de viață [C1–C4]	0 kg CO2 eq.
Raport de mediu	Profilul ambiental al produsului

Use Better

Materiale si ambalare

Pachet cu carton reciclabil	Da
Ambalaj fara plastic	Da
Directiva RoHS a UE	Conform
Regulamentul REACH	Referinta nu contine SVHC peste prag

Use Longer

Prelungire durata de viata

Reparare	Nu
----------	----

Use Again

Reambalare si refabricare

Profil circularitate	Informatii privind sfarsitul duratei de viata
Preluare la sfarsitul duratei de viata	Da

Dimensions Drawings

Dimensions

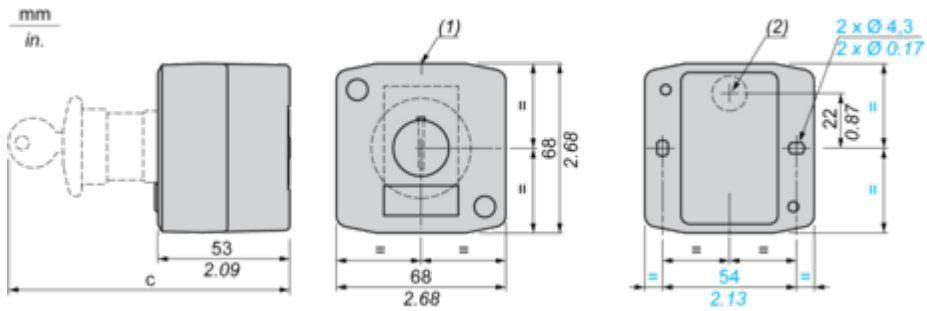

(1) 2 knock-outs for Pg 13.5 cable gland, maximum capacity 12 mm/0.47 in.





(2) Knock-out for cable entry, maximum capacity 14 mm/0.55 in.

Control station fitted with:	c in mm	c in in.
Flush pushbutton	62	2.44
Pilot light	64	2.52
Illuminated pushbutton	65.5	2.58
Projecting pushbutton	66	2.60
Selector switch	80	3.15
Mushroom head pushbutton	91.5	3.58
Latching mushroom head Emergency stop pushbutton with key	115	4.53
Key switch	105.5	4.15

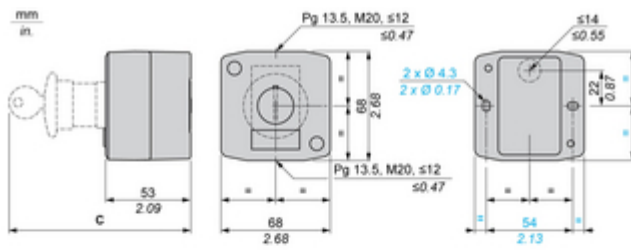
Technical Illustration

Dimensions



C	mm	in.
 ZB5AA●, ZB5AH0●	62	2.44
 ZB5AV●	64	2.52
 ZB5AW3●	65.5	2.58
 ZB5AL●, ZB5AW1●, ZB5AH●, ZB5AH●3	66	2.6
 ZB5AD●, ZB5AK●	80	3.15
 ZB5A56●, ZB5AT●, ZB5AC●, ZB5AR●, ZB5AW4●, ZB5AW6●, ZB5A54●, ZB5A55●, ZB5A56●	91.5	3.58
 ZB5A59●, ZB5AS1●, ZB5AS7●	115	4.53
 ZB5AG●	105.5	4.15

Offer Marketing Illustration

Product benefits / Features

Technical Benefits

Harmony XALK

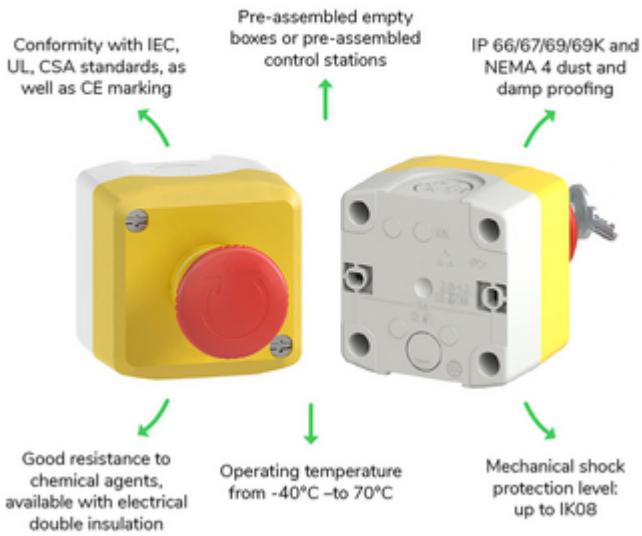

Offer Marketing Illustration

Product benefits / Features

Features Harmony XALK



 Complete stations for emergency stop function with a single mushroom head non-illuminated or illuminated function from XB5 range

 Possibility to add up to 3 NO or NC contact blocks per operating head

 Complete, ready-to-install stations with 1 to 3 buttons for the most common functions

 Polycarbonate pre-drilled control stations

 Modular system and simple to cable universal range

Image of product / Alternate images

Alternative





