



SENTRON 3LD5 switch disconnecter UL, main switch, 3-pole, approved according to UL 489, UL 60947-4-1 and IEC 60947-3, UL: 100 A, SCCR 65 kA at 480 V AC, operational power @ 480 V AC 3-phase: 60 hp, IEC: 100 A, operational power at AC-23 A at 400 V: 45 kW, floor mounting with direct operating mechanism, black, including terminal covers for the infeed side for the infeed side

Model	
product brand name	SENTRON
product designation	Switch disconnecter
design of the product	Main switch
display version for switch position indicator manual operation	1 ON - 0 OFF
type of switch	Floor mounting with direct drive
design of the actuating element	selector switch
color of the actuating element	black
design of handle	knob-operated mechanism, black
type of the driving mechanism motor drive	No
General technical data	
number of poles	3
size of switch disconnecter	3
mechanical service life (operating cycles) typical	100 000
electrical endurance (operating cycles)	
• at AC-23 A at 690 V	6 000
operating frequency maximum	50 1/h
degree of pollution	3
Voltage	
insulation voltage rated value	690 V
surge voltage resistance rated value	6 kV
operating voltage	
• at AC rated value	690 V
operating frequency rated value	
• minimum	50 Hz
• maximum	60 Hz
Protection class	
protection class IP	IP00
protection class IP on the front	IP00
Dissipation	
power loss [W] for rated value of the current at AC in hot operating state per pole	36 W
Main circuit	
operational current	
• at AC-21 at 690 V rated value	100 A
• at AC-21 A at 240 V rated value	100 A
• at AC-21 A at 400 V rated value	100 A
• at AC-21 A at 440 V rated value	100 A

<ul style="list-style-type: none"> at AC-23 A at 400 V rated value 	100 A
operating power	
<ul style="list-style-type: none"> at AC-23 A at 240 V rated value 	30 kW
<ul style="list-style-type: none"> at AC-23 A at 440 V rated value 	45 kW
<ul style="list-style-type: none"> at AC-23 A at 690 V rated value 	37 kW
<ul style="list-style-type: none"> at AC-3 at 240 V rated value 	30 kW
<ul style="list-style-type: none"> at AC-3 at 400 V rated value 	45 kW
<ul style="list-style-type: none"> at AC-3 at 690 V rated value 	30 kW
Auxiliary circuit	
number of CO contacts for auxiliary contacts	0
number of NC contacts for auxiliary contacts	0
number of NO contacts for auxiliary contacts	0
operating voltage of auxiliary contacts at AC maximum	500 V
continuous current of the auxiliary contact rated value	10 A
insulation voltage of the auxiliary switch rated value	500 V
Suitability	
suitability for use main switch	Yes
suitability for use switch disconnecter	Yes
suitability for use EMERGENCY OFF switch	No
suitability for use safety switch	Yes
suitability for use maintenance/repair switch	Yes
Product details	
product feature can be locked into OFF position	Yes
Accessories	
product extension optional	
<ul style="list-style-type: none"> motor drive 	No
<ul style="list-style-type: none"> voltage trigger 	No
number of connectable NC contacts for auxiliary contacts attachable maximum	2
number of connectable NO contacts for auxiliary contacts attachable maximum	4
number of connectable CO contacts for auxiliary contacts attachable maximum	0
number of bracket locks maximum	3
hasp thickness of the bracket locks	5 ... 7.5 mm
Short circuit	
conditional short-circuit current with line-side fuse protection	
<ul style="list-style-type: none"> at 440 V by gG fuse rated value 	50 kA
<ul style="list-style-type: none"> at 690 V by gG fuse rated value 	50 kA
let-through current with closed switch	
<ul style="list-style-type: none"> at 240 V for combination switch + gG fuse maximum 	16 kA
<ul style="list-style-type: none"> at 440 V for combination switch + gG fuse maximum 	16 kA
<ul style="list-style-type: none"> at 690 V for combination switch + gG fuse maximum permissible 	15 kA
I²t value with closed switch	
<ul style="list-style-type: none"> at 240 V for combination switch + gG fuse maximum 	223 kA ² ·s
<ul style="list-style-type: none"> at 440 V for combination switch + gG fuse maximum 	223 kA ² ·s
<ul style="list-style-type: none"> at 690 V for combination switch + gG fuse maximum 	223 kA ² ·s
design of the fuse link	
<ul style="list-style-type: none"> for short-circuit protection of the main circuit required 	Fuse gG: 125 A
<ul style="list-style-type: none"> for short-circuit protection of the auxiliary switch required 	fuse gL/gG: 10 A
operational current of upstream fuse rated value	125 A
according UL	
operational current at AC according to UL 489/UL 60947-4-1 rated value	100 A
operational current at AC according to UL 508/UL 60947-4-1 rated value	100 A
operating voltage at AC at 50/60 Hz according to UL 489 rated value	480 V
operating voltage at AC at 50/60 Hz according to UL 508/UL	480 V

60947-4-1 rated value	
active power [hp] at AC at 480 V according to UL 508/UL 60947-4-1 rated value	60
short-time withstand current (SCCR) at 480 V according to UL 508/UL 60947-4-1 and UL 489	65 kA
continuous current of upstream fuse according to UL rated value	100 A
type of fuse according to UL	Class J

Connections

AWG number as coded connectable conductor cross section solid maximum	
•	3
•	4/0
AWG number as coded connectable conductor cross section solid according to UL 489	
• minimum	3
• maximum	4/0
AWG number as coded connectable conductor cross section solid according to CSA C22.2 No. 5-16	
• minimum	3
• maximum	2/0
type of connectable conductor cross-sections for copper conductor	
• solid	1x (16 ...185mm ²)
• finely stranded with core end processing	1x (16...150mm ²)
• stranded	1x (16...185mm ²)
type of connectable conductor cross-sections for auxiliary contacts	
• solid	2x (0.75 ... 2.5 mm ²), 1x 4 mm ²
• finely stranded with core end processing	2x (0.75 ... 1.5 mm ²), 1x 2.5 mm ²
• stranded	2x (0.75 ... 2.5 mm ²), 1x 4 mm ²
type of electrical connection	
• for main current circuit	box terminal
• for auxiliary contacts	connection terminals

Mechanical Design

height	178 mm
width	113 mm
depth	158 mm
type of device	fixed mounting
fastening method	Built-in unit fixed-mounted version
fastening method	
• 4-hole front mounting	No
• front mounting with central attachment	No
• rail mounting	No
Net Weight	2.02 kg

Environmental conditions

ambient temperature during operation	
• minimum	-25 °C
• maximum	55 °C
ambient temperature during storage	
• minimum	-25 °C
• maximum	55 °C

Approvals Certificates

Environment	General Product Approval
--------------------	--------------------------

[Environmental Con-
firmations](#)



Further information

Information on the packaging

<https://support.industry.siemens.com/cs/ww/en/view/109813875>

Information for data generation and storage

<https://support.industry.siemens.com/cs/ww/en/view/109995012>

Information- and Downloadcenter (Catalogs, Brochures,...)

<https://www.siemens.com/lowvoltage/catalogs>

Industry Mall (Online ordering system)

<https://mall.industry.siemens.com/mall/en/en/Catalog/product?mlfb=3LD5400-0TK11>

Service&Support (Manuals, Certificates, Characteristics, FAQs,...)

<https://support.industry.siemens.com/cs/ww/en/ps/3LD5400-0TK11>

Image database (product images, 2D dimension drawings, 3D models, device circuit diagrams, ...)

https://www.automation.siemens.com/bilddb/cax_en.aspx?mlfb=3LD5400-0TK11

CAX-Online-Generator

<https://www.siemens.com/cax>

Tender specifications

<https://www.siemens.com/specifications>

Characteristic curves

[https://curves.simaris.siemens.com/curves/<mmp_prod_noCOMP="HAUPT"></mmp_prod_no>](https://curves.simaris.siemens.com/curves/<mmp_prod_noCOMP=)

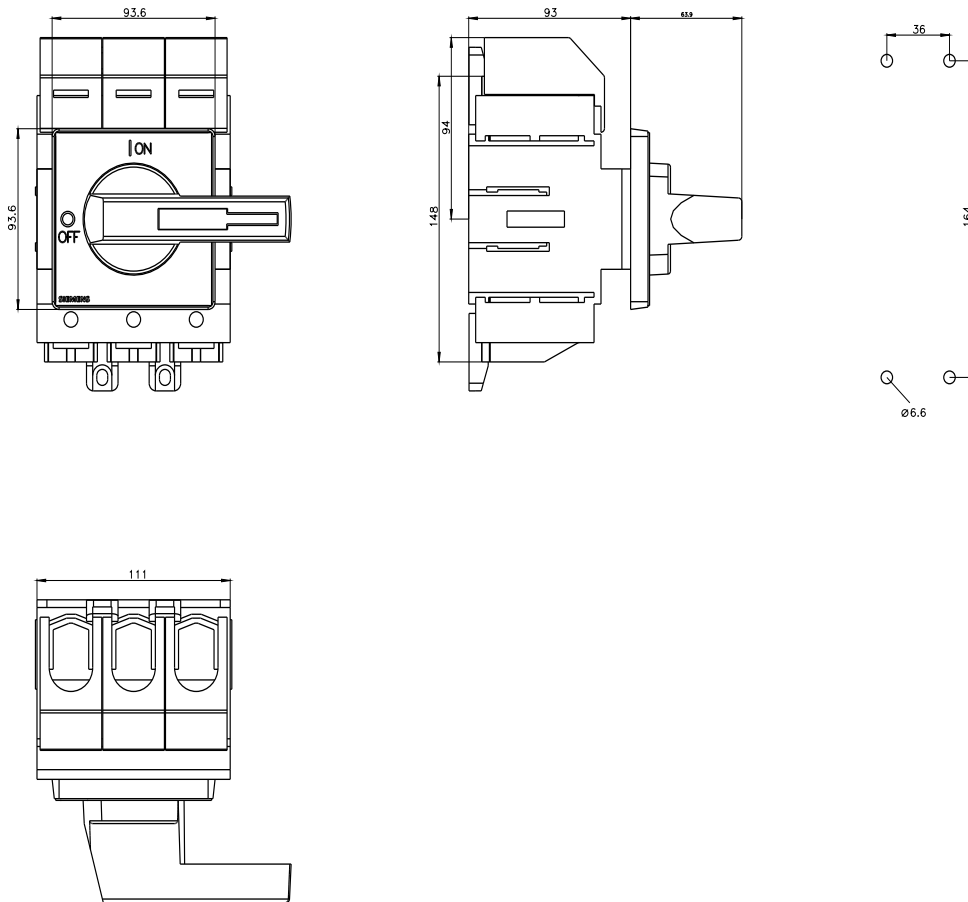

last modified:

10/14/2025

