















Siemens
EcoTech

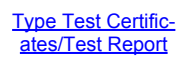
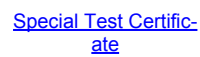

EMERGENCY STOP mushroom pushbutton, 22 mm, round, metal, shiny, red, 40 mm, positive latching, acc. to EN ISO 13850, rotate-to-unlatch

product brand name	SIRIUS ACT
product designation	EMERGENCY STOP mushroom pushbuttons
design of the product	Actuating/signaling element
product type designation	3SU1
product line	Metal, shiny, 22 mm
Enclosure	
number of command points	1
Actuator	
design of the actuating element	positive latching
principle of operation of the actuating element	latching
product extension optional	
• light source	No
• contact module	Yes
color	
• of the actuating element	red
material of the actuating element	plastic
shape of the actuating element	round
outer diameter of the actuating element	40 mm
type of unlocking device	rotate-to-unlatch mechanism
number of switching positions	2
Front ring	
product component front ring	No
General technical data	
product function	
• positive opening	Yes
• EMERGENCY OFF function	Yes
• EMERGENCY STOP function	Yes
protection class IP	IP66, IP67, IP69(IP69K)
degree of protection NEMA rating	1, 2, 3, 3R, 4, 4X, 12, 13
shock resistance	
• according to IEC 60068-2-27	sinusoidal half-wave 15 g / 11 ms
vibration resistance	
• according to IEC 60068-2-6	10 ... 500 Hz: 5 g
operating frequency maximum	600 1/h
mechanical service life (operating cycles) typical	300 000
reference code according to IEC 81346-2	S

Substance Prohibittance (Date)	10/01/2014	
Net Weight	92 g	
Safety related data		
product function suitable for safety function	Yes	
service life maximum	20 a	
test wear-related service life necessary	Yes	
proportion of dangerous failures		
• with low demand rate according to SN 31920	20 %	
• with high demand rate per NC contact according to SN 31920	20 %	
• with high demand rate per NO contact according to SN 31920	50 %	
B10 value with high demand rate according to SN 31920	100 000	
failure rate [FIT] with low demand rate per NC contact according to SN 31920	100 FIT	
ISO 13849		
device type according to ISO 13849-1	3	
IEC 61508		
safety device type according to IEC 61508-2	Type A	
T1 value for proof test interval or service life according to IEC 61508	20 a	
Ambient conditions		
ambient temperature		
• during operation	-25 ... +70 °C	
• during storage	-40 ... +80 °C	
environmental category during operation according to IEC 60721	3M6, 3S2, 3B2, 3C3, 3K6 (with relative air humidity of 10 ... 95%)	
Installation/ mounting/ dimensions		
shape of the installation opening	round	
mounting diameter	22.3 mm	
positive tolerance of installation diameter	0.4 mm	
mounting height	45.3 mm	
installation width	40 mm	
installation depth	26.3 mm	
Approvals Certificates		
Environmental Product Declaration		
• global warming potential [CO2 eq] / during manufacturing	0.625 kg	
• global warming potential [CO2 eq] / during operation	0.235 kg	
• global warming potential [CO2 eq] / after end of life	-0.267 kg	
• global warming potential [CO2 eq] / total	0.593 kg	
Environment	General Product Approval	
     		
General Product Approval	Test Certificates	Maritime application
     		
Maritime application	other	
   		

Further information

Information on the packaging

<https://support.industry.siemens.com/cs/ww/en/view/109813875>

Information for data generation and storage

<https://support.industry.siemens.com/cs/ww/en/view/109995012>

Information- and Downloadcenter (Catalogs, Brochures,...)

<https://www.siemens.com/ic10>

Industry Mall (Online ordering system)

<https://mall.industry.siemens.com/mall/en/en/Catalog/product?mlfb=3SU1050-1HB20-0AA0>

Cax online generator

<https://support.automation.siemens.com/WW/CAXorder/default.aspx?lang=en&mlfb=3SU1050-1HB20-0AA0>

Service&Support (Manuals, Certificates, Characteristics, FAQs,...)

<https://support.industry.siemens.com/cs/ww/en/ps/3SU1050-1HB20-0AA0>

Image database (product images, 2D dimension drawings, 3D models, device circuit diagrams, EPLAN macros, ...)

https://www.automation.siemens.com/bilddb/cax_de.aspx?mlfb=3SU1050-1HB20-0AA0&lang=en

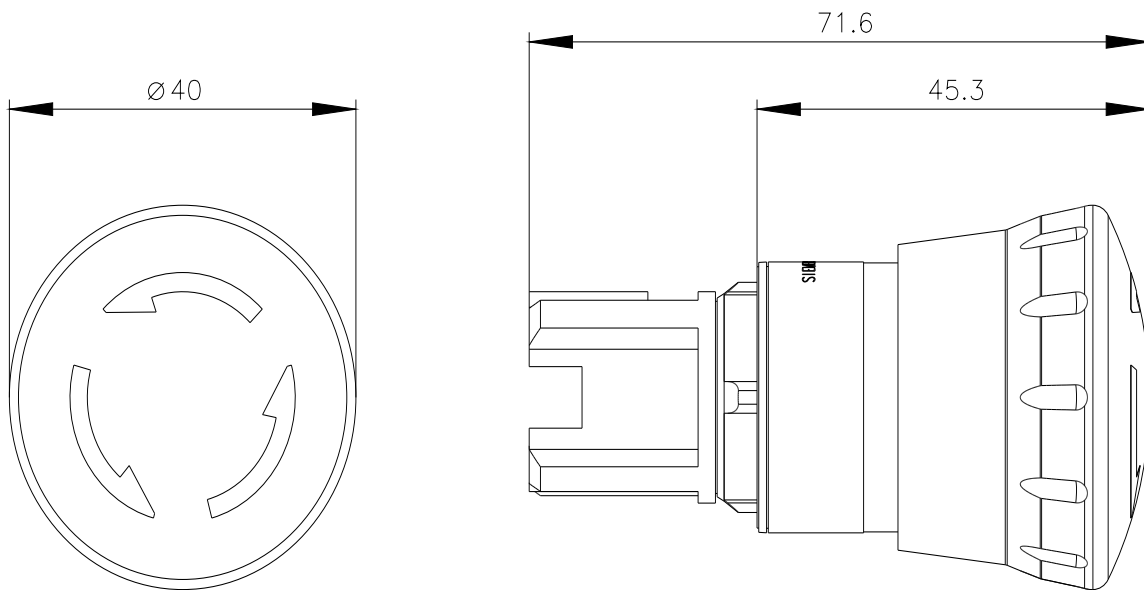

last modified:

4/4/2026 