

# Fișă tehnică produs

Specificatii



## Releu de Interfata, Zelio Rsb, 2 C/O, 230 V C.C., 8 A

RSB2A080P7

### Principale

gama de produse	Harmony Electromechanical Relays
nume serie	RSB series
Tip produs sau componenta	Releu conectabil
tip releu	Interface relay
tip si compozitie contacte	2 C/O
LED de stare	Fara
tensiune circuit de comanda	230 V c.a. 50/60 Hz
tip de control	Fără buton de test cu blocare
[Ithe] curent termic conventional	8 A la -40...40 °C

### Suplimentare

rezistenta medie	33000 Ohm rețea: c.a. la 20 °C +/- 10 %
[Ue] tensiune nominala	184...345 V c.a. 50/60 Hz
[Uimp] tensiune de tinere la impuls	3,6 kV conformitate cu IEC 61000-4-5
[Ie] curent nominal de utilizare	4 A (AC-1/DC-1) NC conformitate cu IEC 8 A (AC-1/DC-1) nu conformitate cu IEC
[Ui] tensiune nominala de izolatie	400 V conformitate cu SR EN 60947
tensiunea maxima de comutatie	300 V c.c. conformitate cu IEC
prag de tensiune pentru decuplare	$\geq 0.15 U_c$ c.a.
curent de sarcina	8 A la 250 V c.a. 8 A la 28 V c.c.
curentul minim comutat	10 mA
capacitate de comutatie maxima	2001 VA/224 W
minimum switching voltage	12 V
capacitate minima de comutatie	120 mW la 10 mA, 12 V
timp de functionare	20 ms funcționare 20 ms resetare
durabilitate mecanica	5000000 cic
durabilitate electrica	100000 cic, 8 A la 250 V, AC-1 nu 100000 cic, 4 A la 250 V, AC-1 NC
fiabilitate securitate date	B10d = 100000
rata de operare	$\leq 600$ cicluri/oră sub sarcină $\leq 18000$ cicluri/oră fara sarcina

consumul mediu in W	0,75 VA c.a.
Removable legend	Fara
categorie de protectie	RT I
pozitie de operare	Orice pozitie
niveluri de testare	Nivel A group mounting
prezentare dispozitiv	Produs complet
cantitate indivizibila de vanzare	10
Material contacte	Aliaj de argint (AgNi)
forma a pinului	Plat (tip PCB)
greutate produs	0,014 kg
Cod compatibilitate	RSB

## Mediu

rigiditate dielectrica	1000 V c.a. între contacte 2500 V c.a. între poli 5000 V c.a. între bobină și contact
rezistenta la vibratii	+/- 1 mm (f= 10...55 Hz) conforming to IEC 60068-2-6
grad de protectie IP	IP40 conforming to SR EN 60529
temperatura ambientala de utilizare	-40...70 °C (c.a.)
standarde	CSA C22.2 No 15 UL 60947-1 IEC 61810-1
certificari produs	CSA EAC UL
temperatura ambietala pentru depozitare	-40...85 °C
rezistenta la socuri	10 gn (durata = 11 ms) pentru nu functioneaza conformitate cu IEC 60068-2-27 5 gn (durata = 11 ms) pentru în functionare conformitate cu IEC 60068-2-27

## Unitati de ambalare

Unitate de masura pentru prima forma de impachetare	PCE
Numar unitati in prima forma de impachetare	1
Inaltime prima forma de impachetare	1,200 cm
Latime prima forma de impachetare	2,000 cm
Lungime prima forma de impachetare	2,900 cm
Greutate prima forma de impachetare	13,000 g
Unitate de masura pentru a doua forma de impachetare	BB1
Numar unitati in a doua forma de impachetare	10
Inaltime a doua forma de impachetare	1,700 cm
Latime a doua forma de impachetare	2,500 cm
Lungime a doua forma de impachetare	31,100 cm
Greutate a doua forma de impachetare	146,000 g

Unitate de masura pentru a treia forma de impachetare	S01
Numar unitati in a treia forma de impachetare	350
Inaltime a treia forma de impachetare	15,000 cm
Latime a treia forma de impachetare	15,000 cm
Lungime a treia forma de impachetare	40,000 cm
Greutate a treia forma de impachetare	5,240 kg

## Garanție contractuală

Garantie	18 luni
----------	---------

## Environmental Data

Schneider Electric isi propune sa atinga nivelul Net Zero pana in 2050 prin parteneriate la nivelul lantului de aprovizionare, materiale cu impact mai redus si circularitate, prin campania „Use Better, Use Longer, Use Again” pentru a extinde durata de viata a produselor si reciclabilitatea.

[Environmental Data explicate >](#)

[Cum evaluam sustenabilitatea produselor >](#)

### **Amprenta de mediu**

Amprenta de carbon (kg CO2 eq.) 12

Raport de mediu [Profilul ambiental al produsului](#)

## Use Better

### **Materiale si ambalare**

Pachet cu carton reciclabil Da

Ambalaj fara plastic Nu

[Directiva RoHS UE](#) Conformitate proactiva (Prodot in afara domeniului de aplicare a EU RoHS)

## Use Again

### **Reambalare si refabricare**

Preluare la sfarsitul duratei de viata No

DEEE  **Prodotul trebuie sa fie eliminat de pe piata din Uniunea Europeana dupa colectarea specifica a deseurilor si sa nu ajunga niciodata in pubele de gunoi**

Dimensions Drawings

Dimensions

---

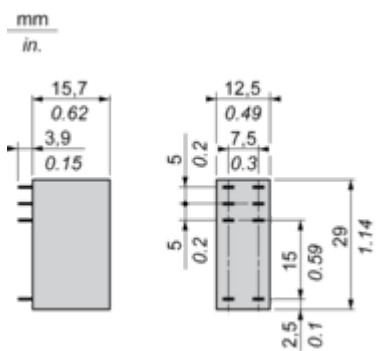

Connections and Schema

Wiring Diagram

---

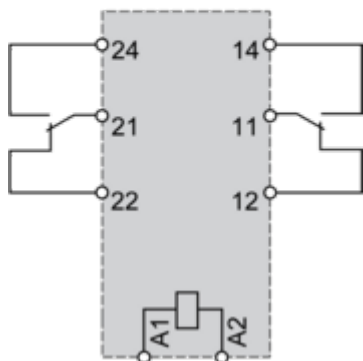
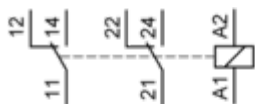

**NOTE:** For DC input, A1 have to be +, otherwise it would short circuit from protection module

Performance Curves

**Electrical Durability of Contacts**

---

**Durability (inductive load) = durability (resistive load) x reduction coefficient.**

Resistive AC load

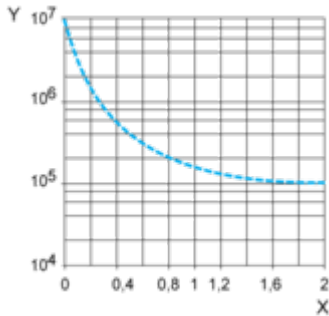

X Switching capacity (kVA)

Y Durability (Number of operating cycles)

Reduction coefficient for inductive AC load (depending on power factor cos φ)

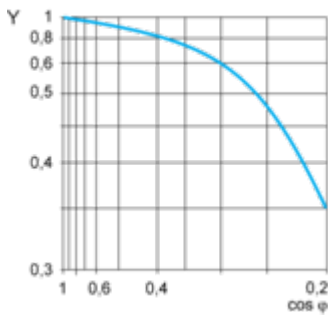

Y Reduction coefficient (A)

Maximum switching capacity on resistive DC load

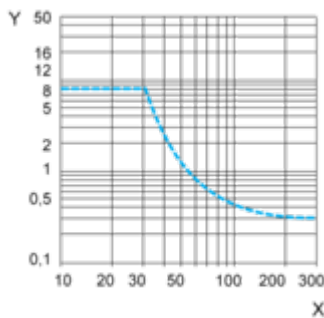

X Voltage DC

Y Current DC

**Note :** These are typical curves, actual durability depends on load, environment, duty cycle, etc.

Technical Illustration

Dimensions

mm  
in.

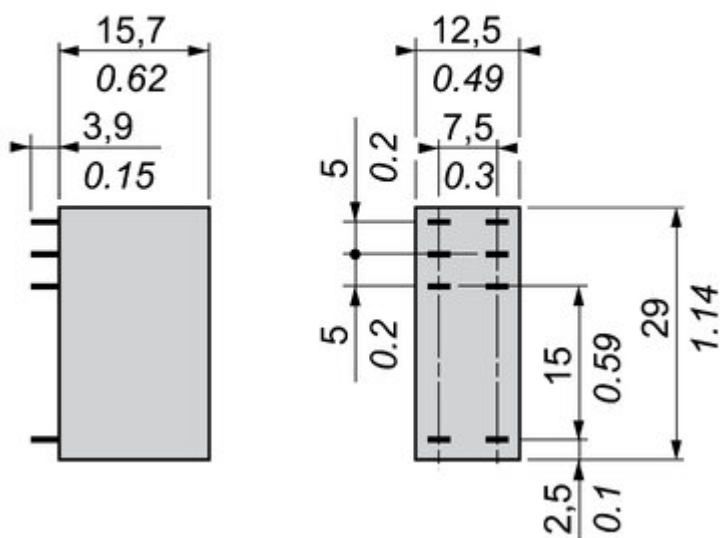
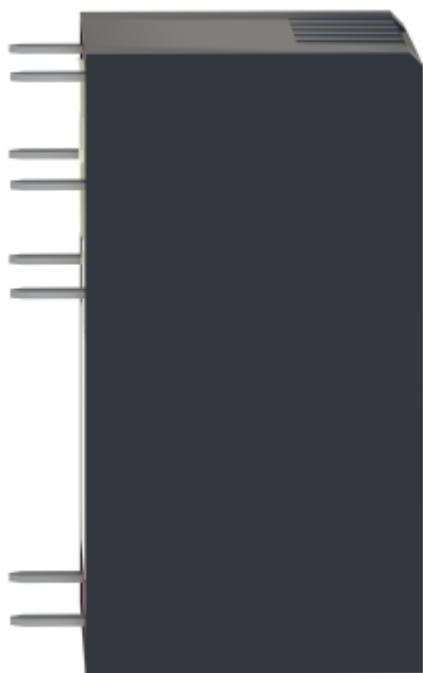

Image of product / Alternate images

Alternative

---



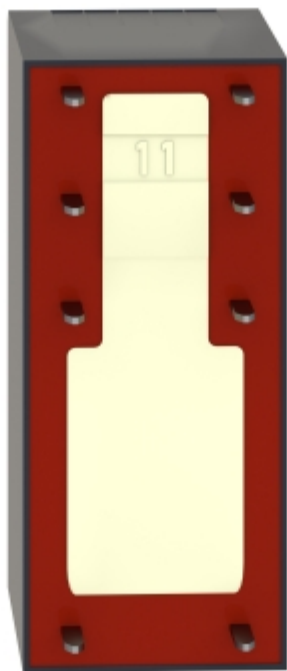

Image of product in real life situation

