

Fișă tehnică produs

Specificatii



Releu de Temporizare 10 Functii, 1 S, 100 H, 24, 240 Vca, 1 Id

RE17RMMU

Principale

gama de produse	Harmony Timer Relays
tip de iesire discreta	Releu
Tip produs sau componenta	Releu de sincronizare modular
latime	17,5 mm
nume scurt al dispozitivului	RE17R
tip intarziere	Power on-delay On-delay and off-delay Interval Temporizare la revenire Symmetrical flashing
intervalul de intarziere	6...60 min 1...10 H 0.1...1 s 1...10 s 1...10 min 10...100 H 6...60 s
curent nominal de iesire	8 A

Suplimentare

tip si compozitie contacte	1 C/O
Material contacte	Fara cadmiu
inaltime	90 mm
adancime	72 mm
tip de control	Selector panou frontal
[Us] tensiune nominala de alimentare	24...240 V c.a. 50/60 Hz 24 V c.c.
interval de tensiune	0,85...1,1 Us
frecventa de alimentare	50...60 Hz +/- 5 %
release of input voltage	10 V
conexiuni - borne	Borne cu surub, 2 x 0.5 - 1 x 3.3 mm ² (AWG 20 - AWG 12) solid fara terminale de cablu Borne cu surub, 3 x 0.5 - 2 x 2.5 mm ² (AWG 20...AWG 14) solid fara terminale de cablu Borne cu surub, 1 x 0.2 - 1 x 2.5 mm ² (AWG 24 - AWG 14) flexibil cu pini Borne cu surub, 2 x 0.2 - 2 x 1.5 mm ² (AWG 24 - AWG 16) flexibil cu pini
cuplu de strangere	0,6...1 N.m conformitate cu IEC 60947-1
material carcasa	Policarbonat
precizie de repetare	+/- 0,5 % conformitate cu IEC 61812-1

Abatere temperatura	+/- 0,05 %/°C
abatere a tensiunii	+/- 0,2 %/V
setarea preciziei temporizarii	+/- 10 % din capatul scarii la 25 °C conformitate cu IEC 61812-1
Time delay type	Power on-delay - A- Power on-delay relay On-delay and off-delay - Ac- On-delay and off-delay relay w/ control signal Power on-delay - At- Power on-delay relay w/ pause/summation (Y1) Interval - B- Single interval relay w/ control signal Interval - Bw- Double interval relay w/ control signal Temporizare la revenire - C- Off-delay relay w/ control signal Symmetrical flashing - D- Symmetrical flashing relay (starting pulse-off) Symmetrical flashing - Di- Symmetrical flashing relay (starting pulse-on) Interval - H- Interval relay Interval - Ht- Interval relay w/ pause/summation (Y1)
control signal pulse width	100 ms cu sarcina în paralel tipic 30 ms tipic
rezistenta de izolatie	100 MΩ la 500 V c.c. conformitate cu SR EN 60664-1
resetare timp	120 ms la întreruperea alimentarii tipic
factor de sarcina	100 %
puterea consumata in VA	0...32 VA la 240 V c.a.
consum de putere maxim in W	0,6 W la 24 V c.c.
curentul minim de comutare	10 mA la 5 V c.c.
curent maxim de comutatie	8 A c.a./c.c.
tensiunea maxima de comutatie	250 V c.a.
capacitate de rupere	2000 VA
operating frequency	10 Hz
durabilitate electrica	100000 cic pentru rezistiv sarcina (8 A la 250 V c.a. maxim)
durabilitate mecanica	10000000 cic
rigiditate dielectrica	2,5 kV 1 mA/1 minut 50 Hz conformitate cu IEC 61812-1
[Uimp] tensiune de tinere la impuls	5 kV in timpul 1.2/50 μs
power on delay	100 ms
marcaj	CE
distanta de conturare	4 kV/3 conformitate cu SR EN 60664-1
fiabilitate securitate date	B10d = 270000 MTTFd = 296.8 ani
pozitia de montaj	Orice poziție în raport cu planul normal vertical de montare
suport de montare	Sina DIN 35 mm conformitate cu IEC 60715
semnalizare locala	Indicator cu LED pentru la funcționare stabilă: releu alimentat, fără temporizare în curs Indicator cu LED 80 % ON și 20 % OFF pentru intermitent: temporizare în curs Indicator cu LED 5 % ON și 95 % OFF pentru impulsuri: releu nealimentat, fără tempo. în progres (excepție funcția Di-D, Li-L)
functie disponibila	A- Power on-delay relay-1 C/O Ac- On-delay and off-delay relay w/ control signal-1 C/O At- Power on-delay relay w/ pause/summation (Y1)-1 C/O B- Single interval relay w/ control signal-1 C/O Bw- Double interval relay w/ control signal-1 C/O C- Off-delay relay w/ control signal-1 C/O D- Symmetrical flashing relay (starting pulse-off)-1 C/O Di- Symmetrical flashing relay (starting pulse-on)-1 C/O H- Interval relay-1 C/O Ht- Interval relay w/ pause/summation (Y1)-1 C/O
greutate produs	0,07 kg

tip de control	Without test button
Number of functions	10
time delay type	A, Ac, At, B, Bw, C, D, Di, H, Ht
functionalitate	Multifuncție
Cod compatibilitate	RE17

Mediu

imunitate la microîntreruperi	20 ms
standarde	2006/95/EC 2004/108/EC IEC 61812-1 IEC 61000-6-2 IEC 61000-6-3 IEC 61000-6-4 IEC 61000-6-1
certificari produs	CSA GL cULus
temperatura ambietala pentru depozitare	-30...60 °C
temperatura ambientala de functionare	-20...60 °C
grad de protectie IP	IP20 conformitate cu SR EN 60529 (cutie de borne) IP40 conformitate cu SR EN 60529 (carcasă) IP50 conformitate cu SR EN 60529 (panou frontal)
rezistenta la vibratii	20 m/s ² (f= 10...150 Hz) conforming to IEC 60068-2-6
rezistenta la socuri	15 gn pentru 11 ms conformitate cu IEC 60068-2-27
umiditate relativa	93 % fără condensare conformitate cu IEC 60068-2-30
compatibilitate electromagnetica	Test de imunitate la descarcari electrostatice nivel de test: 6 kV (în contact) nivel 3 conformitate cu IEC 61000-4-2 Test de imunitate la descarcari electrostatice nivel de test: 9 kV (în aer) nivel 3 conformitate cu IEC 61000-4-2 Sensibilitate la câmpuri electromagnetice nivel de test: 10 V/m (80 MHz la 1 GHz) nivel 3 conformitate cu IEC 61000-4-3 Tranzienți rapizi/test de imunitate la impulsuri de ionizare nivel de test: 1 kV (brida de conectare capacitiva) nivel 3 conformitate cu IEC 61000-4-4 Tranzienți rapizi/test de imunitate la impulsuri de ionizare nivel de test: 2 kV (direct) nivel 3 conformitate cu IEC 61000-4-4 1.2/50 μs test de imunitate la undă de șoc nivel de test: 1 kV (mod diferential) nivel 3 conformitate cu IEC 61000-4-5 1.2/50 μs test de imunitate la undă de șoc nivel de test: 2 kV (mod comun) nivel 3 conformitate cu IEC 61000-4-5 Perturbații conduse de RF nivel de test: 10 V (0.15 - 80 MHz) nivel 3 conformitate cu IEC 61000-4-6 Test de imunitate la căderi de tensiune și întreruperi nivel de test: 1 % (1 ciclu) conformitate cu IEC 61000-4-11 Test de imunitate la căderi de tensiune și întreruperi nivel de test: 71 % (25/30 cicluri) conformitate cu IEC 61000-4-11 Emisii conduse și radiateclasa B conformitate cu EN 55022

Unitati de ambalare

Unitate de masura pentru prima forma de impachetare	PCE
Număr de produse în pachet	1
Inaltime prima forma de impachetare	2,600 cm
Latime prima forma de impachetare	7,800 cm
Lungime prima forma de impachetare	9,500 cm
Greutate colet(Lbs)	80,000 g

Unitate de masura pentru a doua forma de impachetare	S02
Numar unitati in a doua forma de impachetare	40
Inaltime a doua forma de impachetare	15,000 cm
Latime a doua forma de impachetare	30,000 cm
Lungime a doua forma de impachetare	40,000 cm
Greutate a doua forma de impachetare	3,690 kg
Unitate de masura pentru a treia forma de impachetare	P06
Numar unitati in a treia forma de impachetare	640
Inaltime a treia forma de impachetare	75,000 cm
Latime a treia forma de impachetare	60,000 cm
Lungime a treia forma de impachetare	80,000 cm
Greutate a treia forma de impachetare	65,700 kg

Garanție contractuală

Garantie (in luni)	18
--------------------	----

Schneider Electric isi propune sa atinga nivelul Net Zero pana in 2050 prin parteneriate la nivelul lantului de aprovizionare, materiale cu impact mai redus si circularitate, prin campania „Use Better, Use Longer, Use Again” pentru a extinde durata de viata a produselor si reciclabilitatea.

[Environmental Data explicate >](#)

[Cum evaluam sustenabilitatea produselor >](#)

Amprenta de mediu

Amprenta de carbon totala pe durata de viata	53 kg CO2 eq.
Amprenta de carbon a fazei de fabricație [A1–A3]	2 kg CO2 eq.
Amprenta de carbon a fazei de distribuție [A4]	0.1 kg CO2 eq.
Amprenta de carbon a fazei de instalare [A5]	0 kg CO2 eq.
Amprenta de carbon a fazei de utilizare [B2, B3, B4, B6]	51 kg CO2 eq.
Amprenta de carbon a fazei de sfârșit de viață [C1–C4]	0.2 kg CO2 eq.
Raport de mediu	Profilul ambiental al produsului

Use Better

Materiale si ambalare

Pachet cu carton reciclabil	Da
Ambalaj fara plastic	Da
Numar SCIP	7bdc2711-0ad2-427c-8ece-532c5e9f09d7
Directiva RoHS a UE	Conform Prin Scutire
Regulamentul REACH	Referința conține SVHC peste prag

Use Longer

Prelungire durata de viata

Reparare	Nu
----------	----

Use Again

Reambalare si refabricare

Potentialul de reciclabilitate, in %	13
Profil circularitate	Informatii privind sfarsitul duratei de viata
Preluare la sfarsitul duratei de viata	Da

Dimensions Drawings

Width 17.5 mm

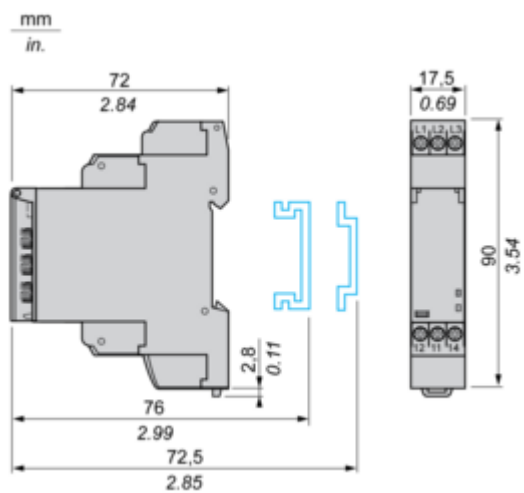

Connections and Schema

Internal Wiring Diagram

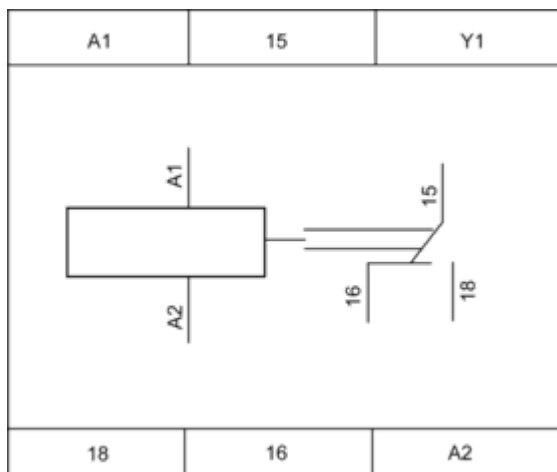

Wiring Diagram

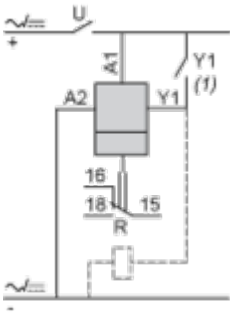

1) Contact Y1:

- Control for functions B, C, Ac, Bw, Ad, Ah, N, O, W, T, Tt.
- Partial stop for functions At, Ht and Pt.
- Function D if Di selected.
- Not used for functions A, H and P.

Technical Description

Function A : Power on Delay Relay

Description

The timing period T begins on energisation. After timing, the output(s) R close(s). The second output can be either timed or instantaneous.

Function: 1 Output

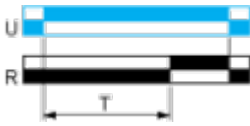

Function: 2 Outputs

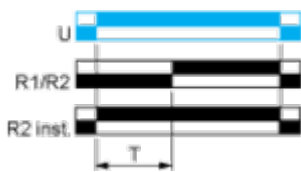

2 timed outputs (R1/R2) or 1 timed output (R1) and 1 instantaneous output (R2 inst.)

Function Ac: On-Delay & Off-Delay with Control Signal

Description

After energisation of power supply and energization of Y1 causes the timing period T to start.
 At the end of this timing period, the output(s) R close(s).
 When deenergization of Y1, the timing T starts.
 At the end of this timing period T, the output(s) R revert(s) to its/their initial position.
 The second output (R2) can be either timed (when set to "TIMED") or instantaneous (when set to "INST").

Function: 1 Output



Function: 2 Outputs

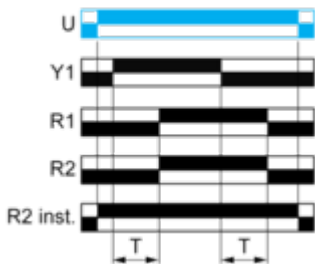

Function At : Power on Delay Relay (Summation) with Control Signal

Description

After power-up, the first opening of control contact C starts the timing. Timing can be interrupted each time control contact closes. When the cumulative total of time periods elapsed reaches the pre-set value T, the output relay closes.

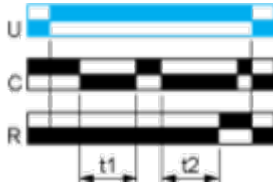
Function: 1 Output

$$T = t1 + t2 + \dots$$

Function B : Interval Relay with Control Signal

Description

After power-up, pulsing or maintaining control contact C starts the timing T. The output R closes for the duration of the timing period T then reverts to its initial state.

Function: 1 Output

Function Bw : Double Interval Relay with Control Signal

Description

On closing and opening of control contact C, the output R closes for the duration of the timing period T.

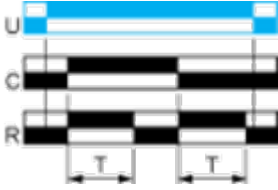
Function: 1 Output

Function C : Off-Delay Relay with Control Signal

Description

After power-up and closing of the control contact C, the output R closes. When control contact C re-opens, timing T starts. At the end of the timing period, the output(s) R revert(s) to its/their initial state. The second output can be either timed or instantaneous.

Function: 1 Output

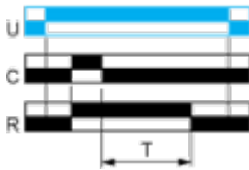

Function: 2 Outputs

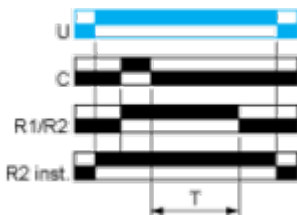

2 timed outputs (R1/R2) or 1 timed output (R1) and 1 instantaneous output (R2 inst.)

Function D: Symmetrical Flashing Relay (Starting Pulse Off)

Description

On energisation of power supply, output(s) R starts at its/their initial state for timing duration T then change(s) to output(s) R close(s) for the same timing duration T. This cycle is repeated indefinitely until power supply removal. Specially for RE17*, RE22R2AMU, RE22R2MMW, RE22R2MMU, RE22R2MJU, this D function can only be initiated by energizing Y1 permanently. The second output (R2) can be either timed (when set to "TIMED") or instantaneous (when set to "INST").

Function: 1 Output



Function: 2 Outputs

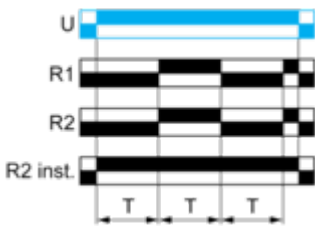

Function: 1 Output with Retrigger / Restart Control

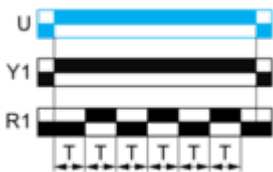

Function: 2 Output with Retrigger / Restart Control

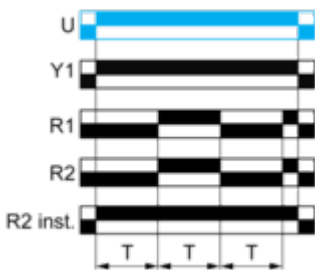

Function Di : Symmetrical Flasher Relay (Starting Pulse On)

Description

Repetitive cycle with two timing periods T of equal duration, with output(s) R changing state at the end of each timing period T.

The second output can be either timed or instantaneous.

Function: 1 Output

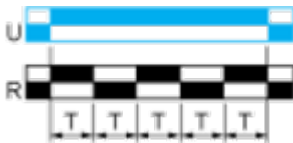

Function: 2 Outputs

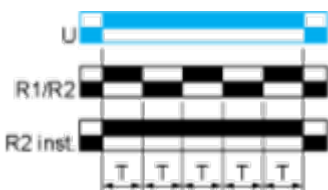

2 timed outputs (R1/R2) or 1 timed output (R1) and 1 instantaneous output (R2 inst.)

Function H : Interval Relay

Description

On energisation of the relay, timing period T starts and the output(s) R close(s). At the end of the timing period T, the output(s) R revert(s) to its/their initial state. The second output can be either timed or instantaneous.

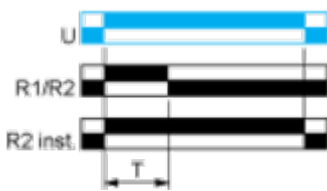
Function: 1 Output**Function: 2 Outputs**

2 timed outputs (R1/R2) or 1 timed output (R1) and 1 instantaneous output (R2 inst.)

Function Ht: Interval Relay & With Pause / Summation Control

Description

On energisation of power supply, output(s) R close(s) and timing period T starts.

The timing can be interrupted / paused each time X1 energizes.

When the cumulative total of time periods elapsed reaches the pre-set value T, the output(s) R revert(s) to its/their initial state. Reenergization of X1 will also cause output(s) R close(s) if the time has elapsed and restart the same operation as described at the beginning.

Except for RE17*, RE22R2MMW, RENF22R2MMW, RE22R2MMU and RE22R2MJU, timing can be interrupted / paused each time Y1 energizes.

The second output (R2) can be either timed (when set to "TIMED" or instantaneous (when set to "INST").

Function: 1 Output

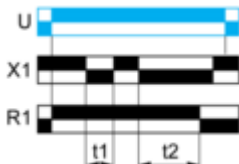

$T = t1 + t2 + \dots$

Function: 2 Outputs

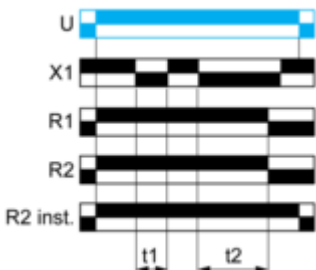

$T = t1 + t2 + \dots$

Function: 1 Output with Retrigger / Restart Control

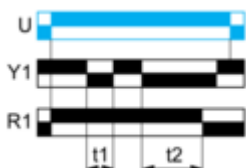



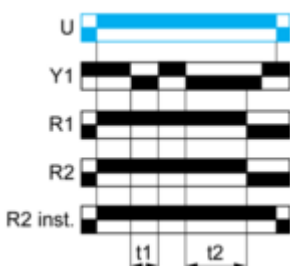

$T = t1 + t2 + \dots$

Function: 2 Outputs with Retrigger / Restart Control



$T = t1 + t2 + \dots$

Legend

	Relay de-energised
	Relay energised
	Output open
	Output closed

C	Control contact
G	Gate
R	Relay or solid state output
R1/R2	2 timed outputs
R2 inst.	The second output is instantaneous if the right position is selected
T	Timing period
Ta -	Adjustable On-delay
Tr -	Adjustable Off-delay
U	Supply

Technical Illustration

Dimensions

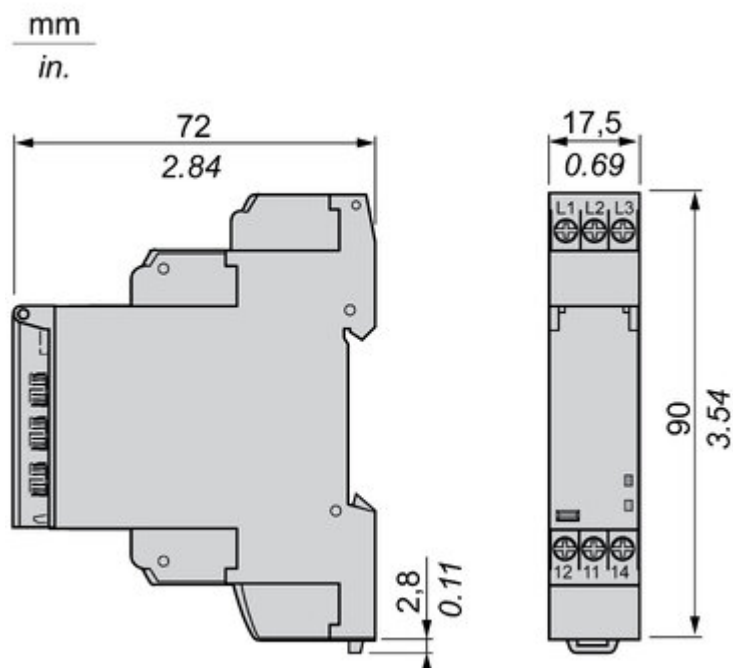

Offer Marketing Illustration

Product benefits / Features

Technical Benefits

Harmony Timer Relay

Flexible choice of screw or spring connection terminals for wiring.

One product reference covering 28 timing functions, 2 outputs, and a wide range of supply voltage 24...240 V AC/DC.

Dust and unintended human intervention avoided thanks to the IP50 lead-sealable settings protection cover.



A Dial-Pointer LED indicator that enhances ease of operation in difficult environments such as dusty or low-light conditions

Different mounting style to meet your preference:
DIN rail mount with product width; 17.5 mm/0.69 in.
22.5 mm/0.88 in.
Plug in mounting with socket



Offer Marketing Illustration

Product benefits / Features



Features

Harmony Timer Relay

-  "Diagnostic button" to check downstream circuit immediately, shorten the commission and troubleshooting time
-  Compatible with a wide range of applications including machines, buildings, water segments, and HVAC.
-  Wide range of time delay for adjustment: from 0.01 s to 999 hrs.
-  Compliant with IEC 60255-1 standard, and a wide array of product certifications such as UL, CE, CSA, EAC.
-  Unprecedented accuracy, predictive maintenance, and superior security.

Image of product / Alternate images

Alternative







Image of product in real life situation

