

Fișă tehnică produs

Specificatii



Releu miniatura 3A,4C/O, cu LED, 24V C.C.

RXM4LB2BD

Principale

gama de produse	Harmony Electromechanical Relays
nume serie	RXM series
Tip produs sau componenta	Releu conectabil
tip releu	Miniature relay
tip si compozitie contacte	4 C/O
tensiune circuit de comanda	24 V c.c.
[Ithe] curent termic conventional	3 A la -40...55 °C

Suplimentare

LED de stare	Cu
tip de control	Fără buton de test cu blocare
[Ie] curent nominal de utilizare	1,5 A la 28 V (DC) NC conformitate cu IEC 1,5 A la 250 V (AC) NC conformitate cu IEC 3 A la 28 V (DC) nu conformitate cu IEC 3 A la 250 V (AC) nu conformitate cu IEC 3 A la 24 V (DC) nu conformitate cu IEC 3 A la 220 V (AC) nu conformitate cu IEC 3 A la 28 V (DC) conformitate cu UL 3 A la 250 V (AC) conformitate cu UL
capacitate minima de comutatie	25 mW subject to switching frequency, environment or expected reliability level etc
limite ale tensiunii nominale de functionare	19.2...26.4 V c.c.
[Ui] tensiune nominala de izolatie	250 V conformitate cu IEC
tensiunea maxima de comutatie	250 V c.a. 28 V c.c.
prag de tensiune pentru decuplare	$\geq 0.1 U_c$ c.c.
curent de sarcina	3 A la 250 V c.a. 3 A la 28 V c.c.
capacitate de comutatie maxima	750 VA c.a. 84 W c.c.
curentul minim de comutare	5 mA subject to switching frequency, environment or expected reliability level etc
tensiunea minima de comutare	5 V subject to switching frequency, environment or expected reliability level etc
rezistenta medie	640 Ohm la 23 °C +/- 10 %
consumul mediu in W	0,9 W, c.c.
durabilitate mecanica	20000000 cic
fiabilitate securitate date	B10d = 100000
rata de operare	≤ 1200 cicluri/oră sub sarcină ≤ 18000 cicluri/oră fara sarcina

coeficient de utilizare	20 %
rigiditate dielectrica	2000 V c.a. între bobină și contact cu Izolatie de baza izolație 2000 V c.a. între poli cu Izolatie de baza izolație 1000 V c.a. între contacte cu micro deconectare izolație
categorie de protectie	RT I
Grad de poluare	2
pozitie de operare	Orice pozitie
niveluri de testare	Nivel A group mounting
cantitate indivizibila de vanzare	10
Material contacte	Aliaj de argint (Ag/Ni)
forma a pinului	Flat (faston type)
greutate produs	0,034 kg

Mediu

standarde	IEC 61810-1 (iss. 2) CE UL 60947-1
temperatura ambietala pentru depozitare	-40...85 °C
rezistenta la vibratii	3 gn, amplitudine = +/- 1 mm (f = 10...50 Hz)funcționare conformitate cu IEC 60068-2-6 6 gn, amplitudine = +/- 1 mm (f = 10...50 Hz)nu functioneaza conformitate cu IEC 60068-2-6
rezistenta la socuri	30 gn pentru nu functioneaza conformitate cu IEC 60068-2-27 10 gn pentru în functionare conformitate cu IEC 60068-2-27

Unitati de ambalare

Unitate de masura pentru prima forma de impachetare	PCE
Număr de produse în pachet	1
Inaltime prima forma de impachetare	2 cm
Latime prima forma de impachetare	3 cm
Lungime prima forma de impachetare	4,5 cm
Greutate colet(Lbs)	35,5 g
Unitate de masura pentru a doua forma de impachetare	BB1
Numar unitati in a doua forma de impachetare	10
Inaltime a doua forma de impachetare	3,4 cm
Latime a doua forma de impachetare	10,4 cm
Lungime a doua forma de impachetare	12,8 cm
Greutate a doua forma de impachetare	393 g
Unitate de masura pentru a treia forma de impachetare	S02
Numar unitati in a treia forma de impachetare	270
Inaltime a treia forma de impachetare	15 cm
Latime a treia forma de impachetare	30 cm
Lungime a treia forma de impachetare	40 cm

Greutate a treia forma de impachetare	11,102 kg
--	-----------

Garanție contractuală

Garantie (in luni)	18
--------------------	----

Schneider Electric isi propune sa atinga nivelul Net Zero pana in 2050 prin parteneriate la nivelul lantului de aprovizionare, materiale cu impact mai redus si circularitate, prin campania „Use Better, Use Longer, Use Again” pentru a extinde durata de viata a produselor si reciclabilitatea.

[Environmental Data explicate >](#)

[Cum evaluam sustenabilitatea produselor >](#)

Amprenta de mediu

Amprenta de carbon totala pe durata de viata	13 kg CO2 eq.
Amprenta de carbon a fazei de fabricație [A1–A3]	0.3 kg CO2 eq.
Amprenta de carbon a fazei de distribuție [A4]	0 kg CO2 eq.
Amprenta de carbon a fazei de instalare [A5]	0 kg CO2 eq.
Amprenta de carbon a fazei de utilizare [B2, B3, B4, B6]	13 kg CO2 eq.
Amprenta de carbon a fazei de sfârșit de viață [C1–C4]	0 kg CO2 eq.
Raport de mediu	Profilul ambiental al produsului

Use Better

Materiale si ambalare

Pachet cu carton reciclabil	Da
Ambalaj fara plastic	Da
Directiva RoHS a UE	Conform
Regulamentul REACH	Referinta nu contine SVHC peste prag

Use Longer

Prelungire durata de viata

Reparare	Nu
----------	----

Use Again

Reambalare si refabricare

Profil circularitate	Informatii privind sfarsitul duratei de viata
Preluare la sfarsitul duratei de viata	Da
Eticheta WEEE	 În Uniunea Europeana, produsele trebuie reciclate respectand sistemul specific de colectare a deseurilor si nu trebuie sa ajunga in pubelele de colectare a deseurilor menajere.

Dimensions Drawings

Dimensions

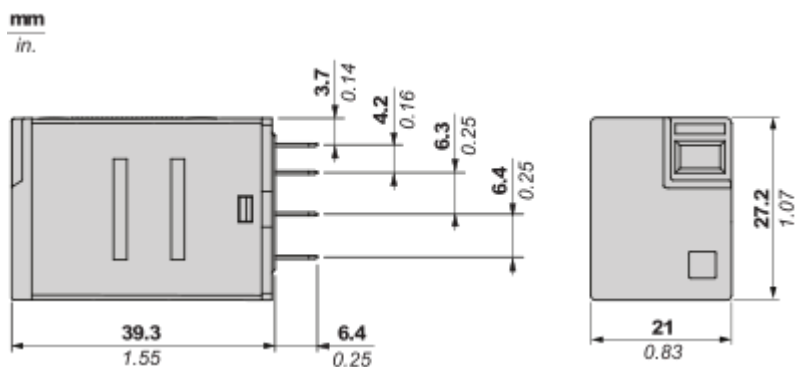

Pin Side View

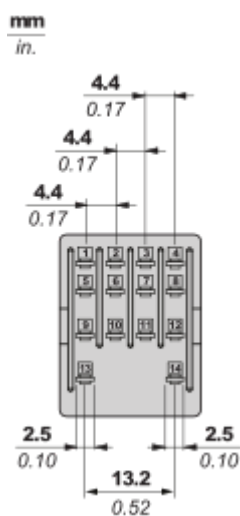

Connections and Schema

Wiring Diagram

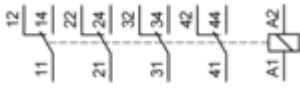

Symbols shown in blue correspond to Nema marking.

Performance Curves

Electrical Durability of Contacts

Durability (inductive load) = durability (resistive load) x reduction coefficient.

For 4 Poles Relay

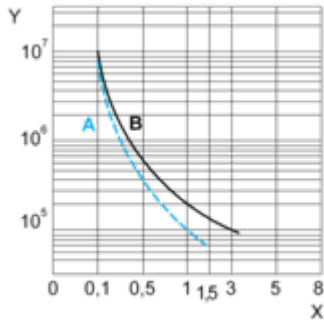

X : Contact current (A)

Y : Durability (Number of operating cycles)

A : Inductive load

B : Resistive load

Note : These are typical curves, actual durability depends on load, environment, duty cycle, etc.

For inductive load, to increase relay life cycles, please add a proper load protection circuit (eg: RC protection/Varistor/free Wheeling diode -DC load only-)

Maximum Switching Capacity

For 4 Poles Relay

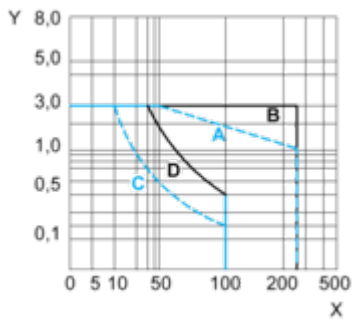
**X** : Contact voltage (v)**Y** : Contact current (A)**A** : Inductive AC load**B** : Resistive AC load**C** : Inductive DC load**D** : Resistive DC load**Note** : These are typical curves, actual durability depends on load, environment, duty cycle, etc.

For inductive load, to increase relay life cycles, please add a proper load protection circuit (eg: RC protection/Varistor/free Wheeling diode -DC load only-)

For low level loads (below 10mA), we recommend to use RXM*GB series with bifurcated contacts relays instead.

Technical Illustration

Dimensions

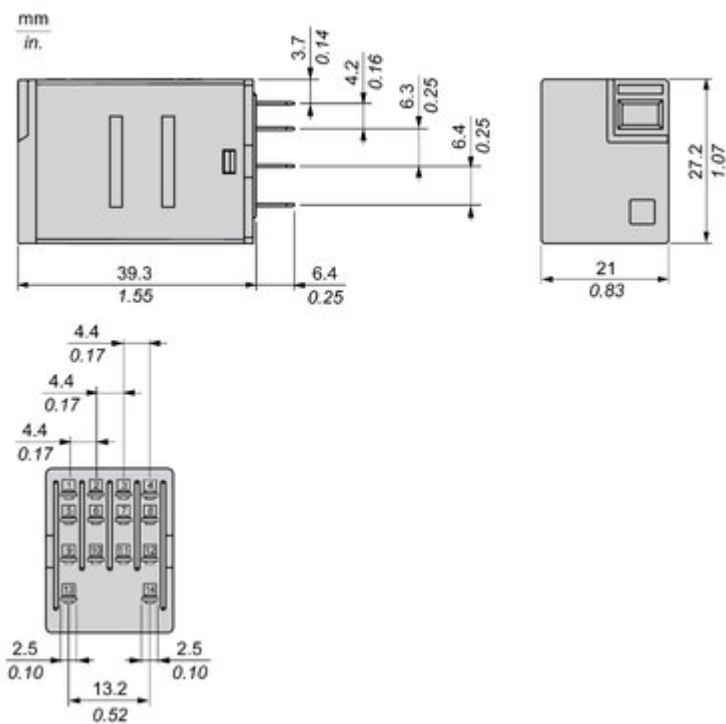

Offer Marketing Illustration

Product benefits / Features



Features
Easy Harmony RXMLB Relay

Fit to customer needs
coverage of most general control panel applications

Easy to select
simple selection and wide availability

Convenient to use
Easy status readiness through mechanical indicator & LED

Safe to perform
product reliability, compliance with industrial standard and eco-design

The image features a central photograph of a black RXMLB relay mounted on a terminal block. The relay has a grey cover with a small window showing the internal mechanism. It is surrounded by four circular icons: a plug, a magnifying glass, crossed wrench and screwdriver, and a checkmark. The background is a solid green color.

Offer Marketing Illustration

Product benefits / Features

Technical Benefits

Easy Harmony RXMLB Relay

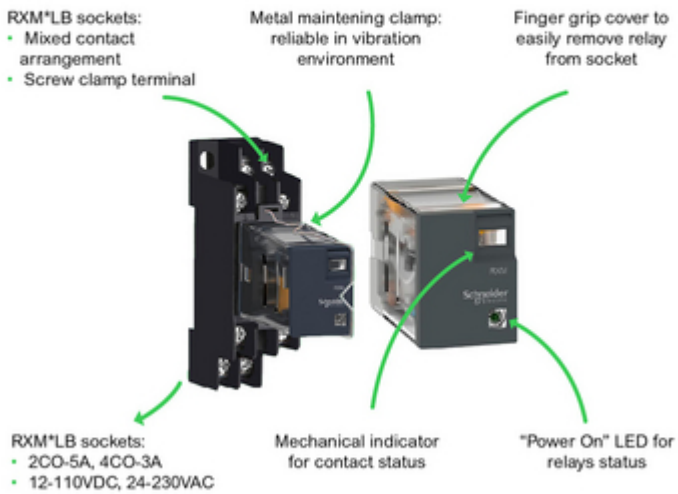

Image of product / Alternate images

Alternative

