



circuit breaker frame size S0 for motor protection, Class 10 thermal release 23...28 A short-circuit release 364 A spring-loaded terminal standard switching capacity with transverse auxiliary switch 1 NO+1 NC

product brand name	SIRIUS
product designation	Circuit breaker
design of the product	For motor protection
product type designation	3RV2
General technical data	
size of the circuit-breaker	S0
size of contactor can be combined company-specific	S00, S0
product extension auxiliary switch	Yes
power loss [W] for rated value of the current	
• at AC in hot operating state	13.25 W
• at AC in hot operating state per pole	4.4 W
insulation voltage with degree of pollution 3 at AC rated value	690 V
surge voltage resistance rated value	6 kV
shock resistance according to IEC 60068-2-27	25g / 11 ms
mechanical service life (operating cycles)	
• of the main contacts typical	100 000
• of auxiliary contacts typical	100 000
electrical endurance (operating cycles) typical	100 000
reference code according to IEC 81346-2	Q
Substance Prohibition (Date)	10/01/2009
Net Weight	448 g
Ambient conditions	
installation altitude at height above sea level maximum	2 000 m
ambient temperature	
• during operation	-20 ... +60 °C
• during storage	-50 ... +80 °C
• during transport	-50 ... +80 °C
relative humidity during operation	10 ... 95 %
Main circuit	
number of poles for main current circuit	3
adjustable current response value current of the current-dependent overload release	23 ... 28 A
type of voltage for main current circuit	AC
operating voltage	
• rated value	20 ... 690 V
• at AC-3 rated value maximum	690 V

<ul style="list-style-type: none"> ● at AC-3e rated value maximum 	690 V
operating frequency rated value	50 ... 60 Hz
operational current rated value	28 A
operational current	
<ul style="list-style-type: none"> ● at AC-3 at 400 V rated value 	28 A
<ul style="list-style-type: none"> ● at AC-3e at 400 V rated value 	28 A
operating power	
<ul style="list-style-type: none"> ● at AC-3 <ul style="list-style-type: none"> — at 230 V rated value — at 400 V rated value — at 500 V rated value — at 690 V rated value 	7.5 kW 15 kW 18.5 kW 22 kW
<ul style="list-style-type: none"> ● at AC-3e <ul style="list-style-type: none"> — at 230 V rated value — at 400 V rated value — at 500 V rated value — at 690 V rated value 	7.5 kW 15 kW 18.5 kW 22 kW
operating frequency	
<ul style="list-style-type: none"> ● at AC-3 maximum 	15 1/h
<ul style="list-style-type: none"> ● at AC-3e maximum 	15 1/h
Auxiliary circuit	
design of the auxiliary switch	transverse
type of voltage for auxiliary and control circuit	AC/DC
number of NC contacts for auxiliary contacts	1
number of NO contacts for auxiliary contacts	1
number of CO contacts for auxiliary contacts	0
operational current of auxiliary contacts at AC-15	
<ul style="list-style-type: none"> ● at 24 V ● at 120 V ● at 125 V ● at 230 V 	2 A 0.5 A 0.5 A 0.5 A
operational current of auxiliary contacts at DC-13	
<ul style="list-style-type: none"> ● at 24 V ● at 60 V 	1 A 0.15 A
Protective and monitoring functions	
product function	
<ul style="list-style-type: none"> ● ground fault detection ● phase failure detection 	No Yes
trip class	CLASS 10
design of the overload release	thermal
maximum short-circuit current breaking capacity (Icu)	
<ul style="list-style-type: none"> ● at AC at 240 V rated value ● at AC at 400 V rated value ● at AC at 500 V rated value ● at AC at 690 V rated value 	100 kA 55 kA 10 kA 4 kA
operating short-circuit current breaking capacity (Ics) at AC	
<ul style="list-style-type: none"> ● at 240 V rated value ● at 400 V rated value ● at 500 V rated value ● at 690 V rated value 	100 kA 25 kA 5 kA 2 kA
response value current of instantaneous short-circuit trip unit	364 A
UL/CSA ratings	
full-load current (FLA) for 3-phase AC motor	
<ul style="list-style-type: none"> ● at 480 V rated value ● at 600 V rated value 	28 A 28 A
yielded mechanical performance [hp]	
<ul style="list-style-type: none"> ● for single-phase AC motor <ul style="list-style-type: none"> — at 110/120 V rated value — at 230 V rated value 	2 hp 5 hp

<ul style="list-style-type: none"> ● for 3-phase AC motor <ul style="list-style-type: none"> — at 200/208 V rated value — at 220/230 V rated value — at 460/480 V rated value 	7.5 hp 10 hp 20 hp
contact rating of auxiliary contacts according to UL	C300 / R300
UL File Number (CCN)	E47705 (NLRV, NLRV7), E156943 (NKJH, NKJH7)
Short-circuit protection	
product function short circuit protection	Yes
design of the short-circuit trip	magnetic
design of the fuse link <ul style="list-style-type: none"> ● for short-circuit protection of the auxiliary switch required 	Fuse gL/gG: 10 A, miniature circuit breaker C 6 A (short-circuit current $I_k < 400$ A)
design of the fuse link for IT network for short-circuit protection of the main circuit <ul style="list-style-type: none"> ● at 400 V ● at 500 V ● at 690 V 	gL/gG 63 A gL/gG 63 A gL/gG 63 A
Installation/ mounting/ dimensions	
mounting position	any
fastening method	screw and snap-on mounting onto 35 mm DIN rail according to DIN EN 60715
height	119 mm
width	45 mm
depth	97 mm
required spacing <ul style="list-style-type: none"> ● with side-by-side mounting at the side ● for grounded parts at 400 V <ul style="list-style-type: none"> — downwards — upwards — at the side ● for live parts at 400 V <ul style="list-style-type: none"> — downwards — upwards — at the side ● for grounded parts at 500 V <ul style="list-style-type: none"> — downwards — upwards — at the side ● for live parts at 500 V <ul style="list-style-type: none"> — downwards — upwards — at the side ● for grounded parts at 690 V <ul style="list-style-type: none"> — downwards — upwards — backwards — at the side — forwards ● for live parts at 690 V <ul style="list-style-type: none"> — downwards — upwards — backwards — at the side — forwards 	0 mm 30 mm 30 mm 9 mm 30 mm 30 mm 9 mm 30 mm 30 mm 9 mm 50 mm 50 mm 0 mm 30 mm 0 mm 50 mm 50 mm 0 mm 30 mm 0 mm
Connections/ Terminals	
type of electrical connection <ul style="list-style-type: none"> ● for main current circuit ● for auxiliary and control circuit 	spring-loaded terminals spring-loaded terminals
arrangement of electrical connectors for main current circuit	Top and bottom
type of connectable conductor cross-sections	

<ul style="list-style-type: none"> • for main contacts <ul style="list-style-type: none"> — solid or stranded — finely stranded with core end processing — finely stranded without core end processing • for AWG cables for main contacts 	2x (1 ... 10 mm ²) 2x (1 ... 6 mm ²) 2x (1 ... 6 mm ²) 2x (18 ... 8)
type of connectable conductor cross-sections <ul style="list-style-type: none"> • for auxiliary contacts <ul style="list-style-type: none"> — solid or stranded — finely stranded with core end processing — finely stranded without core end processing • for AWG cables for auxiliary contacts 	2x (0.5 ... 2.5 mm ²) 2x (0.5 ... 1.5 mm ²) 2x (0.5 ... 1.5 mm ²) 2x (20 ... 14)
design of screwdriver shaft	Diameter 3 mm
size of the screwdriver tip	3,0 x 0,5 mm

Safety related data

product function suitable for safety function	Yes
suitability for use	
<ul style="list-style-type: none"> • safety-related switching on • safety-related switching OFF 	No Yes
service life maximum	10 a
test wear-related service life necessary	Yes
proportion of dangerous failures	
<ul style="list-style-type: none"> • with low demand rate according to SN 31920 • with high demand rate according to SN 31920 	40 % 50 %
B10 value with high demand rate according to SN 31920	5 000
failure rate [FIT] with low demand rate according to SN 31920	50 FIT

ISO 13849

device type according to ISO 13849-1	3
overdimensioning according to ISO 13849-2 necessary	Yes

IEC 61508

safety device type according to IEC 61508-2	Type A
T1 value	
<ul style="list-style-type: none"> • for proof test interval or service life according to IEC 61508 	10 a

Electrical Safety

protection class IP on the front according to IEC 60529	IP20
touch protection on the front according to IEC 60529	finger-safe, for vertical contact from the front

Display

display version for switching status	Handle
--------------------------------------	--------

Approvals Certificates

Environmental Product Declaration	
<ul style="list-style-type: none"> • global warming potential [CO2 eq] / during manufacturing • global warming potential [CO2 eq] / during sales • global warming potential [CO2 eq] / during operation • global warming potential [CO2 eq] / after end of life • global warming potential [CO2 eq] / total 	2.68 kg 0.143 kg 72.7 kg -0.445 kg 75.078 kg

Environment **General Product Approval**





[Environmental Confirmations](#)







General Product Approval **For use in hazardous locations** **Maritime application**





other

[Confirmation](#)

[Miscellaneous](#)

Further information

Information on the packaging

<https://support.industry.siemens.com/cs/ww/en/view/109813875>

Information for data generation and storage

<https://support.industry.siemens.com/cs/ww/en/view/109995012>

Information- and Downloadcenter (Catalogs, Brochures,...)

<https://www.siemens.com/ic10>

Industry Mall (Online ordering system)

<https://mall.industry.siemens.com/mall/en/en/Catalog/product?mlfb=3RV2021-4NA25>

Service&Support (Manuals, Certificates, Characteristics, FAQs,...)

<https://support.industry.siemens.com/cs/ww/en/ps/3RV2021-4NA25>

Image database (product images, 2D dimension drawings, 3D models, device circuit diagrams, EPLAN macros, ...)

https://www.automation.siemens.com/bilddb/cax_de.aspx?mlfb=3RV2021-4NA25&lang=en

Cax online generator

<https://support.automation.siemens.com/WW/CAXorder/default.aspx?lang=en&mlfb=3RV2021-4NA25>

Characteristic curves

[https://curves.simaris.siemens.com/curves/<mmp_prod_noCOMP="HAUPT"></mmp_prod_no>](https://curves.simaris.siemens.com/curves/<mmp_prod_noCOMP=)

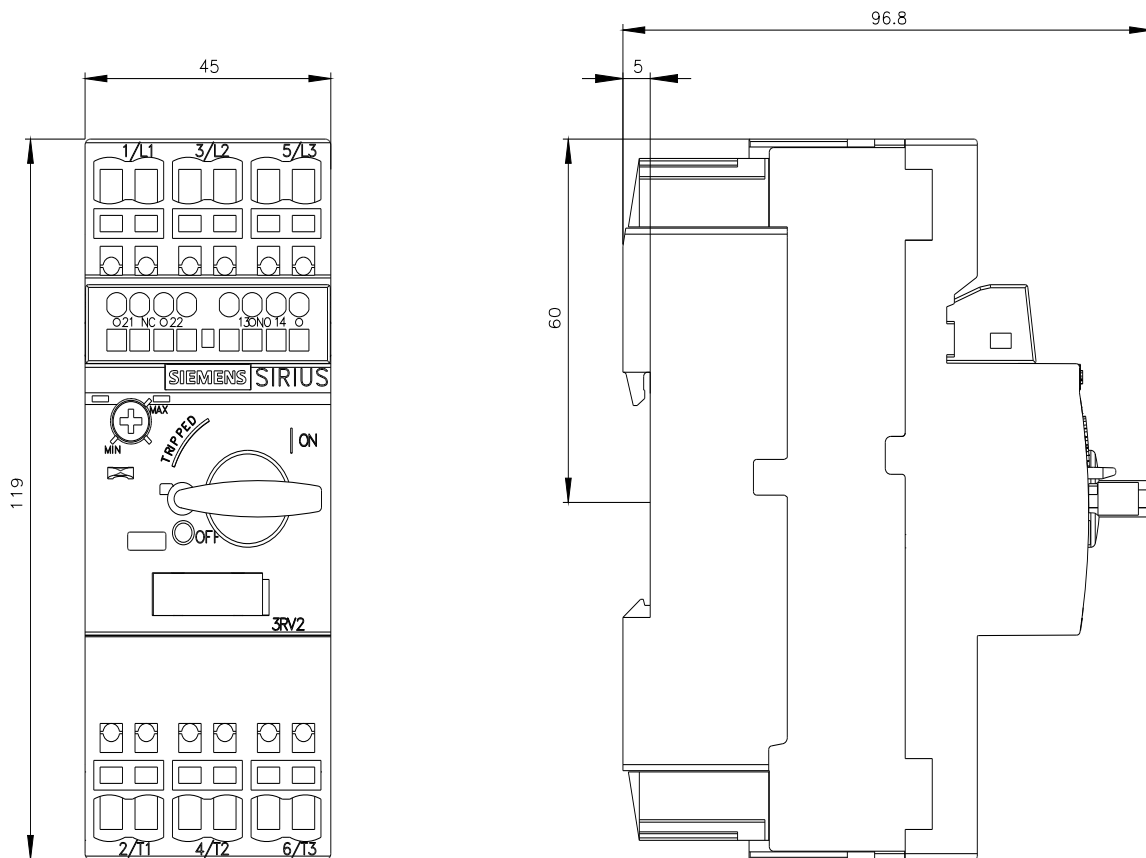

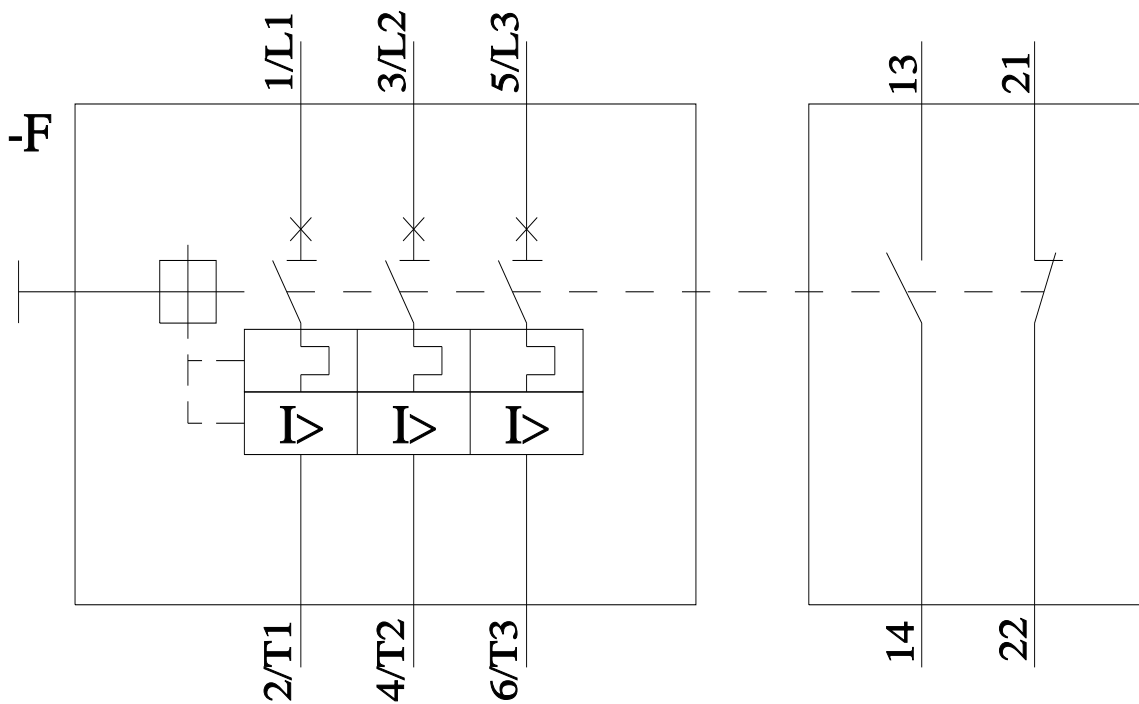
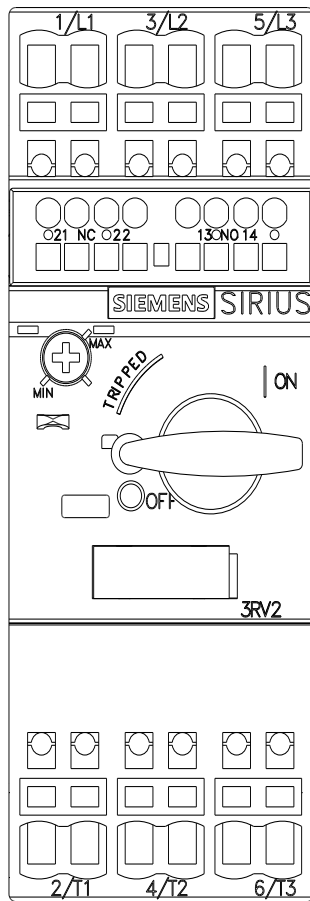

last modified:

3/8/2026