

















LED module with integrated LED 110 V AC, green, screw terminal, for front plate mounting

<b>product brand name</b>	SIRIUS ACT
<b>product designation</b>	LED module
<b>product type designation</b>	3SU1
<b>General technical data</b>	
<b>product component</b>	
• diode	Yes
• lamp transformer	No
• light source	Yes
• series resistor	No
<b>insulation voltage rated value</b>	320 V
<b>degree of pollution</b>	3
type of voltage of the operating voltage	AC
• for actuation	AC
<b>surge voltage resistance rated value</b>	4 kV
consumed current maximum	20 mA
<b>protection class IP</b>	
• of the enclosure	IP40
• of the terminal	IP20
<b>shock resistance</b>	
• according to IEC 60068-2-27	sinusoidal half-wave 15 g / 11 ms
• for railway applications according to EN 61373	Category 1, Class B
<b>vibration resistance</b>	
• according to IEC 60068-2-6	10 ... 500 Hz: 5 g
• for railway applications according to EN 61373	Category 1, Class B
<b>operating period typical</b>	100 000 h
<b>reference code according to IEC 81346-2</b>	P
<b>Substance Prohibitance (Date)</b>	10/01/2014
<b>SVHC substance name</b>	Lead monoxide (lead oxide) CAS-No. 1317-36-8 2-methyl-1-(4-methylthiophenyl)-2-morpholinopropan-1-one CAS-No. 71868-10-5
<b>Net Weight</b>	10 g
<b>operating voltage 1</b>	
• at AC	
— at 50 Hz rated value	110 V
— at 60 Hz rated value	110 V
<b>relative positive tolerance of the operating voltage</b>	20 %
<b>relative negative tolerance of the operating voltage</b>	20 %

Control circuit/ Control	
inrush current maximum	3 A
Connections/ Terminals	
type of electrical connection	screw terminal
type of connectable conductor cross-sections	
<ul style="list-style-type: none"> <li>• solid with core end processing</li> <li>• solid without core end processing</li> <li>• finely stranded with core end processing</li> <li>• finely stranded without core end processing</li> <li>• for AWG cables</li> </ul>	2x (0.5 ... 0.75 mm <sup>2</sup> ) 2x (1.0 ... 1.5 mm <sup>2</sup> ) 2x (0.5 ... 1.5 mm <sup>2</sup> ) 2x (1.0 ... 1.5 mm <sup>2</sup> ) 2x (18 ... 14)
connectable conductor cross-section finely stranded with core end processing	0.5 ... 1.5 mm <sup>2</sup>
tightening torque with screw-type terminals	0.8 ... 0.9 N·m
Lamp	
type of light source	LED
color of the light source	green
light intensity	900 ... 1 400 mcd
ATEX	
certificate of suitability	
<ul style="list-style-type: none"> <li>• ATEX</li> <li>• IECEx</li> </ul>	No No
Ambient conditions	
ambient temperature	
<ul style="list-style-type: none"> <li>• during operation</li> <li>• during storage</li> </ul>	-25 ... +70 °C -40 ... +80 °C
environmental category during operation according to IEC 60721	3M6, 3S2, 3B2, 3C3, 3K6 (with relative air humidity of 10 ... 95%, no condensation in operation permitted)
Installation/ mounting/ dimensions	
fastening method	
<ul style="list-style-type: none"> <li>• of modules and accessories</li> </ul>	Front plate mounting
height	33.2 mm
width	9.8 mm
depth	29.4 mm
Approvals Certificates	
Environmental Product Declaration	
<ul style="list-style-type: none"> <li>• global warming potential [CO<sub>2</sub> eq] / during manufacturing</li> <li>• global warming potential [CO<sub>2</sub> eq] / during operation</li> <li>• global warming potential [CO<sub>2</sub> eq] / after end of life</li> <li>• global warming potential [CO<sub>2</sub> eq] / total</li> </ul>	0.566 kg 0.235 kg -0.0145 kg 0.787 kg
Environment	
General Product Approval	
   <a href="#">Environmental Conformations</a>   	
General Product Approval	
EMV	Test Certificates
  	<a href="#">Special Test Certificate</a> <a href="#">Type Test Certificates/Test Report</a>
Maritime application	
	
Maritime application	
other	
    <a href="#">Confirmation</a>	

Further information

Information on the packaging

<https://support.industry.siemens.com/cs/ww/en/view/109813875>

Information for data generation and storage

<https://support.industry.siemens.com/cs/ww/en/view/109995012>

Information- and Downloadcenter (Catalogs, Brochures,...)

<https://www.siemens.com/ic10>

Industry Mall (Online ordering system)

<https://mall.industry.siemens.com/mall/en/en/Catalog/product?mlfb=3SU1401-1BC40-1AA0>

Cax online generator

<https://support.automation.siemens.com/WW/CAXorder/default.aspx?lang=en&mlfb=3SU1401-1BC40-1AA0>

Service&Support (Manuals, Certificates, Characteristics, FAQs,...)

<https://support.industry.siemens.com/cs/ww/en/ps/3SU1401-1BC40-1AA0>

Image database (product images, 2D dimension drawings, 3D models, device circuit diagrams, EPLAN macros, ...)

[https://www.automation.siemens.com/bilddb/cax\\_de.aspx?mlfb=3SU1401-1BC40-1AA0&lang=en](https://www.automation.siemens.com/bilddb/cax_de.aspx?mlfb=3SU1401-1BC40-1AA0&lang=en)

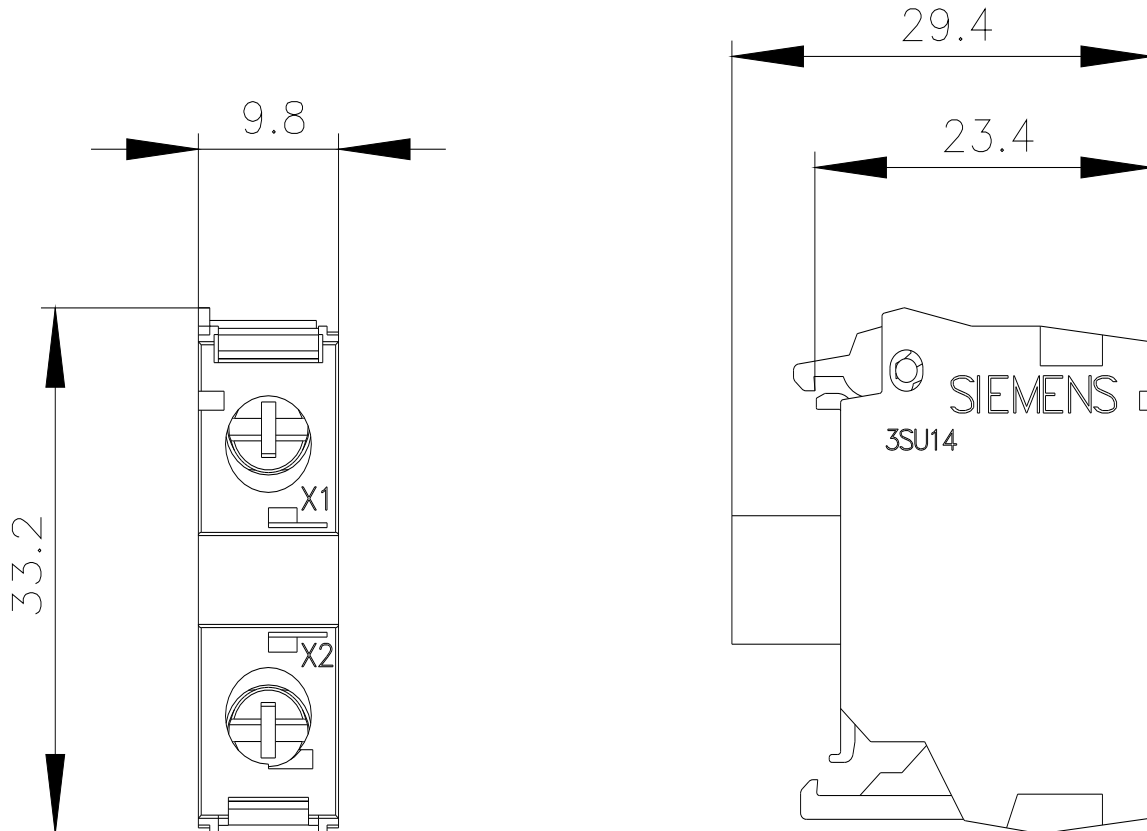



last modified:

4/4/2026 