







Figure similar

Position switch with Roller plunger, Metal enclosure 40 mm according to EN 50041, 1 NO/1 NC quick action contact with M12 connector, 5-pole, Fixed, with 2 LEDs, yellow/green, 24 V DC, 4 A, Pin assignment: Pin1=21+13 Jumper + LED green, Pin2=22, Pin3 = ground LED, Pin4=14 + LED yellow, Pin5=PE

product brand name	SIRIUS
product designation	Mechanical position switches
product type designation	3SE5
manufacturer's article number	
<ul style="list-style-type: none"> • of the supplied basic switch • of the supplied actuator head for position switches • of the supplied switching contacts 	3SE5114-1CA00-1AF5 3SE5000-0AD02 3SE5000-0CA00
suitability for use safety switch	Yes
General technical data	
product function positive opening	Yes
insulation voltage rated value	125 V
degree of pollution	class 3
surge voltage resistance rated value	0.8 kV
protection class IP	IP66/IP67
shock resistance	
<ul style="list-style-type: none"> • according to IEC 60068-2-27 	30 g / 11 ms
vibration resistance according to IEC 60068-2-6	0.35 mm/5 g
mechanical service life (operating cycles) typical	15 000 000
thermal current	4 A
material of the enclosure of the switch head	metal
reference code according to IEC 81346-2	B
continuous current of the C characteristic MCB	1 A; for a short-circuit current smaller than 400 A
continuous current of the quick DIAZED fuse link	4 A; for a short-circuit current smaller than 400 A
continuous current of the DIAZED fuse link gG	4 A
active principle	mechanical
repeat accuracy	0.05 mm
Substance Prohibitance (Date)	07/01/2006
SVHC substance name	Lead CAS-No. 7439-92-1 Imidazolidine-2-thione (2-imidazoline-2-thiol) CAS-No. 96-45-7
Net Weight	0.37 kg
minimum actuating force in directions of actuation	20 N
length of the sensor	130.5 mm
width of the sensor	40 mm
Ambient conditions	
ambient temperature	
<ul style="list-style-type: none"> • during operation • during storage 	-25 ... +60 °C -40 ... +90 °C
explosion protection category for dust	none

Main circuit	
design of the switching contact	mechanical
number of NC contacts for auxiliary contacts	1
number of NO contacts for auxiliary contacts	1
operational current at DC-13	3 A
• at 24 V rated value	
Enclosure	
design of the housing	block, narrow
material of the enclosure	metal
coating of the enclosure	cathodic dip coating
design of the housing according to standard	Yes
Drive Head	
design of the actuating element	Roller plunger, high-grade steel roller
standard-compliant actuator head	EN 50041, design C
shape of the switch head	roller
design of the switching function	positive opening
circuit principle	snap-action contacts
number of switching contacts safety-related	1
cable entry type	M12 plug
design of plug-in connection	M12 connector, 5-pole: pin 1= terminal 21/13/LED green, pin 2= 22, pin 3= ground LED, pin 4= 14/LED yellow, pin 5= PE
Installation/ mounting/ dimensions	
mounting position	any
fastening method	screw fixing
Connections/ Terminals	
type of electrical connection	M12 plug, fixed
Supply voltage	
type of voltage of the supply voltage of the optional LED display	DC
supply voltage of LED	24 V
•	
design of the interface for safety-related communication	without
Communication/ Protocol	
design of the interface	without
Safety related data	
product function suitable for safety function	Yes
service life maximum	20 a
test wear-related service life necessary	Yes
proportion of dangerous failures	20 %
• with low demand rate according to SN 31920	
• with high demand rate according to SN 31920	
B10 value with high demand rate according to SN 31920	1 000 000
failure rate [FIT] with low demand rate according to SN 31920	100 FIT
ISO 13849	
device type according to ISO 13849-1	3
IEC 61508	
safety device type according to IEC 61508-2	A
Approvals Certificates	
General Product Approval	Test Certificates
    	Type Test Certificates/Test Report
other	Environment



Confirmation



Environmental Con-
firmations

Further information

Information on the packaging

<https://support.industry.siemens.com/cs/ww/en/view/109813875>

Information for data generation and storage

<https://support.industry.siemens.com/cs/ww/en/view/109995012>

Information- and Downloadcenter (Catalogs, Brochures,...)

<https://www.siemens.com/ic10>

Industry Mall (Online ordering system)

<https://mall.industry.siemens.com/mall/en/en/Catalog/product?mlfb=3SE5114-1CD02-1AF5>

Cax online generator

<https://support.automation.siemens.com/WW/CAXorder/default.aspx?lang=en&mlfb=3SE5114-1CD02-1AF5>

Service&Support (Manuals, Certificates, Characteristics, FAQs,...)

<https://support.industry.siemens.com/cs/ww/en/ps/3SE5114-1CD02-1AF5>

Image database (product images, 2D dimension drawings, 3D models, device circuit diagrams, EPLAN macros, ...)

https://www.automation.siemens.com/bilddb/cax_de.aspx?mlfb=3SE5114-1CD02-1AF5&lang=en

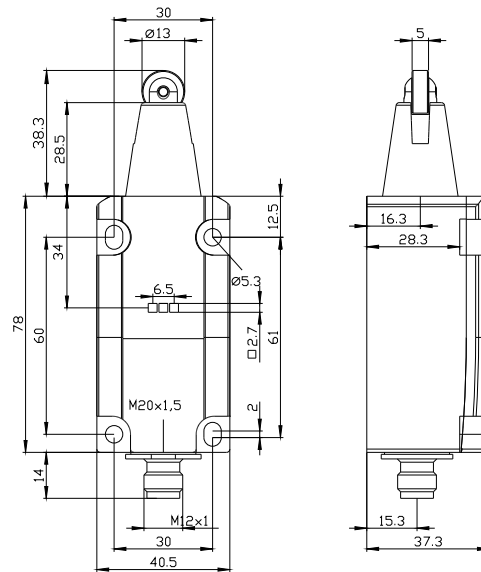

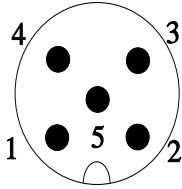

1	BN = Brown	→	21
2	WH = White	→	22
3	BU = Blue	→	GND LED
4	BK = Black	→	14+LED-Yellow
5	GN/YE = Green/Yellow	→	⊖
-	-	→	Bridge 13-21
-	-	→	13+LED-Green

