



Circuit breaker size S0 for motor protection, CLASS 10 A-release 10...16 A N-release 208 A screw terminal Standard switching capacity

product brand name	SIRIUS
product designation	Circuit breaker
design of the product	For motor protection
product type designation	3RV2
General technical data	
size of the circuit-breaker	S0
size of contactor can be combined company-specific	S00, S0
product extension auxiliary switch	Yes
power loss [W] for rated value of the current	
• at AC in hot operating state	9.25 W
• at AC in hot operating state per pole	3.1 W
insulation voltage with degree of pollution 3 at AC rated value	690 V
surge voltage resistance rated value	6 kV
shock resistance according to IEC 60068-2-27	25g / 11 ms
mechanical service life (operating cycles)	
• of the main contacts typical	100 000
• of auxiliary contacts typical	100 000
electrical endurance (operating cycles) typical	100 000
reference code according to IEC 81346-2	Q
Substance Prohibition (Date)	10/01/2009
Net Weight	363 g
Ambient conditions	
installation altitude at height above sea level maximum	2 000 m
ambient temperature	
• during operation	-20 ... +60 °C
• during storage	-50 ... +80 °C
• during transport	-50 ... +80 °C
relative humidity during operation	10 ... 95 %
Main circuit	
number of poles for main current circuit	3
adjustable current response value current of the current-dependent overload release	10 ... 16 A
type of voltage for main current circuit	AC
operating voltage	
• rated value	20 ... 690 V
• at AC-3 rated value maximum	690 V

<ul style="list-style-type: none"> ● at AC-3e rated value maximum 	690 V
operating frequency rated value	50 ... 60 Hz
operational current rated value	16 A
operational current	
<ul style="list-style-type: none"> ● at AC-3 at 400 V rated value ● at AC-3e at 400 V rated value 	16 A 16 A
operating power	
<ul style="list-style-type: none"> ● at AC-3 <ul style="list-style-type: none"> — at 230 V rated value — at 400 V rated value — at 500 V rated value — at 690 V rated value ● at AC-3e <ul style="list-style-type: none"> — at 230 V rated value — at 400 V rated value — at 500 V rated value — at 690 V rated value 	4 kW 7.5 kW 7.5 kW 11 kW 4 kW 7.5 kW 7.5 kW 11 kW
operating frequency	
<ul style="list-style-type: none"> ● at AC-3 maximum ● at AC-3e maximum 	15 1/h 15 1/h

Auxiliary circuit	
type of voltage for auxiliary and control circuit	AC/DC
number of NC contacts for auxiliary contacts	0
number of NO contacts for auxiliary contacts	0
number of CO contacts for auxiliary contacts	0

Protective and monitoring functions	
product function	
<ul style="list-style-type: none"> ● ground fault detection ● phase failure detection 	No Yes
trip class	CLASS 10
design of the overload release	thermal
maximum short-circuit current breaking capacity (Icu)	
<ul style="list-style-type: none"> ● at AC at 240 V rated value ● at AC at 400 V rated value ● at AC at 500 V rated value ● at AC at 690 V rated value 	100 kA 55 kA 10 kA 4 kA
operating short-circuit current breaking capacity (Ics) at AC	
<ul style="list-style-type: none"> ● at 240 V rated value ● at 400 V rated value ● at 500 V rated value ● at 690 V rated value 	100 kA 25 kA 5 kA 2 kA
response value current of instantaneous short-circuit trip unit	208 A

UL/CSA ratings	
full-load current (FLA) for 3-phase AC motor	
<ul style="list-style-type: none"> ● at 480 V rated value ● at 600 V rated value 	16 A 16 A
yielded mechanical performance [hp]	
<ul style="list-style-type: none"> ● for single-phase AC motor <ul style="list-style-type: none"> — at 110/120 V rated value — at 230 V rated value ● for 3-phase AC motor <ul style="list-style-type: none"> — at 200/208 V rated value — at 220/230 V rated value — at 460/480 V rated value 	1 hp 2 hp 3 hp 5 hp 10 hp
UL File Number (CCN)	E47705 (NLRV, NLRV7), E156943 (NKJH, NKJH7)

Short-circuit protection	
product function short circuit protection	Yes
design of the short-circuit trip	magnetic
design of the fuse link for IT network for short-circuit	

protection of the main circuit	
<ul style="list-style-type: none"> ● at 400 V ● at 500 V ● at 690 V 	<ul style="list-style-type: none"> gL/gG 63 A gL/gG 50 A gL/gG 40 A
Installation/ mounting/ dimensions	
mounting position	any
fastening method	screw and snap-on mounting onto 35 mm DIN rail according to DIN EN 60715
height	97 mm
width	45 mm
depth	97 mm
required spacing	
<ul style="list-style-type: none"> ● with side-by-side mounting at the side ● for grounded parts at 400 V <ul style="list-style-type: none"> — downwards — upwards — at the side ● for live parts at 400 V <ul style="list-style-type: none"> — downwards — upwards — at the side ● for grounded parts at 500 V <ul style="list-style-type: none"> — downwards — upwards — at the side ● for live parts at 500 V <ul style="list-style-type: none"> — downwards — upwards — at the side ● for grounded parts at 690 V <ul style="list-style-type: none"> — downwards — upwards — backwards — at the side — forwards ● for live parts at 690 V <ul style="list-style-type: none"> — downwards — upwards — backwards — at the side — forwards 	<ul style="list-style-type: none"> 0 mm 30 mm 30 mm 9 mm 30 mm 30 mm 9 mm 30 mm 30 mm 9 mm 50 mm 50 mm 0 mm 30 mm 0 mm 50 mm 50 mm 0 mm 30 mm 0 mm
Connections/ Terminals	
type of electrical connection	
<ul style="list-style-type: none"> ● for main current circuit 	screw-type terminals
arrangement of electrical connectors for main current circuit	Top and bottom
type of connectable conductor cross-sections	
<ul style="list-style-type: none"> ● for main contacts <ul style="list-style-type: none"> — solid or stranded — finely stranded with core end processing ● for AWG cables for main contacts 	<ul style="list-style-type: none"> 2x (1 ... 2.5 mm²), 2x (2.5 ... 10 mm²) 2x (1 ... 2.5 mm²), 2x (2.5 ... 6 mm²), 1x 10 mm² 2x (16 ... 12), 2x (14 ... 8)
tightening torque	
<ul style="list-style-type: none"> ● for main contacts with screw-type terminals 	2 ... 2.5 N·m
design of screwdriver shaft	Diameter 5 to 6 mm
size of the screwdriver tip	Pozidriv size 2
design of the thread of the connection screw	
<ul style="list-style-type: none"> ● for main contacts 	M4
Safety related data	
product function suitable for safety function	Yes
suitability for use	

• safety-related switching on	No
• safety-related switching OFF	Yes
service life maximum	10 a
test wear-related service life necessary	Yes
proportion of dangerous failures	
• with low demand rate according to SN 31920	40 %
• with high demand rate according to SN 31920	50 %
B10 value with high demand rate according to SN 31920	5 000
failure rate [FIT] with low demand rate according to SN 31920	50 FIT

ISO 13849	
device type according to ISO 13849-1	3
overdimensioning according to ISO 13849-2 necessary	Yes

IEC 61508	
safety device type according to IEC 61508-2	Type A
T1 value	
• for proof test interval or service life according to IEC 61508	10 a

Electrical Safety	
protection class IP on the front according to IEC 60529	IP20
touch protection on the front according to IEC 60529	finger-safe, for vertical contact from the front

Display	
display version for switching status	Handle

Approvals Certificates

Environmental Product Declaration	
• global warming potential [CO2 eq] / during manufacturing	2.68 kg
• global warming potential [CO2 eq] / during sales	0.143 kg
• global warming potential [CO2 eq] / during operation	72.7 kg
• global warming potential [CO2 eq] / after end of life	-0.445 kg
• global warming potential [CO2 eq] / total	75.078 kg

Environment **General Product Approval**



[Environmental Confirmations](#)









General Product Approval **For use in hazardous locations** **Maritime application**

Maritime application **other**





[Confirmation](#)

other

[Miscellaneous](#)

Further information

Information on the packaging

<https://support.industry.siemens.com/cs/ww/en/view/109813875>

Information for data generation and storage

<https://support.industry.siemens.com/cs/ww/en/view/109995012>

Information- and Downloadcenter (Catalogs, Brochures,...)

<https://www.siemens.com/ic10>

Industry Mall (Online ordering system)

<https://mall.industry.siemens.com/mall/en/en/Catalog/product?mlfb=3RV2021-4AA10>

Service&Support (Manuals, Certificates, Characteristics, FAQs,...)

<https://support.industry.siemens.com/cs/ww/en/ps/3RV2021-4AA10>

Image database (product images, 2D dimension drawings, 3D models, device circuit diagrams, EPLAN macros, ...)

https://www.automation.siemens.com/bilddb/cax_de.aspx?mlfb=3RV2021-4AA10&lang=en

Cax online generator

<https://support.automation.siemens.com/WW/CAXorder/default.aspx?lang=en&mlfb=3RV2021-4AA10>

Characteristic curves

[https://curves.simaris.siemens.com/curves/<mmp_prod_noCOMP="HAUPT"></mmp_prod_no>](https://curves.simaris.siemens.com/curves/<mmp_prod_noCOMP=)

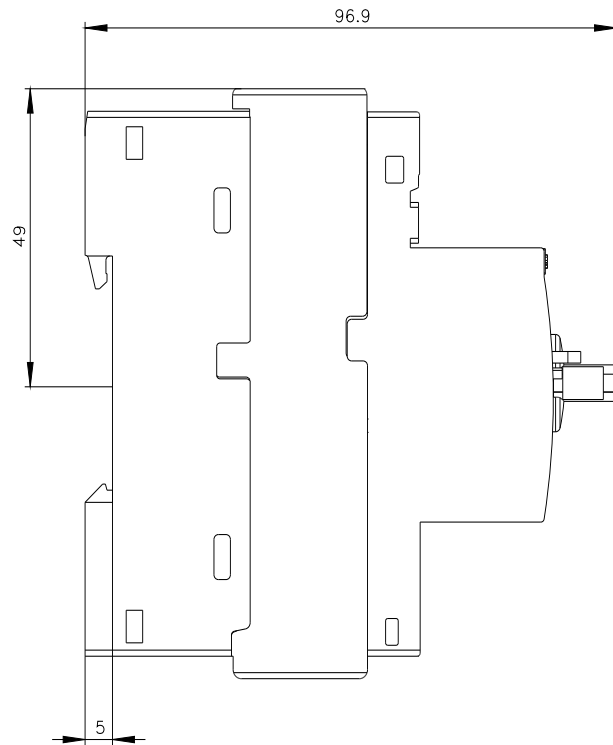
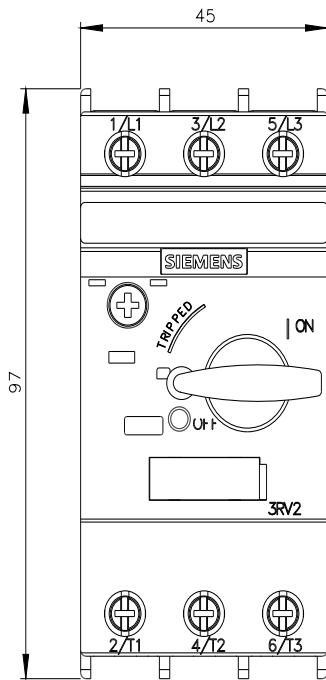



last modified:

3/8/2026 ↻